

PENNSYLVANIA
VEGETABLE GROWERS

NEWS

January 2015 / Volume 38 Number 1

for the commercial vegetable, potato and berry grower

2015 Buyers' Guide



GENERAL



**Pennsylvania
Vegetable Growers
Association**

*An association of
commercial vegetable,
potato and berry growers.*

President

Brian Campbell '15
Berwick

First Vice President

Robert Shenot '16
Wexford

Second Vice President

David Miller '14
York

Secretary-Treasurer

William Reynolds '16
Waynesboro

Past President

Arthur King
Valencia

Directors

Robert Amsterdam '14
Mechanicsburg

Fred Dymond III '14
Dallas

Curtis Kaelin '15
Wexford

David King '16
Bakerstown

Lois Klinger '16
Catawissa

Kenneth Martin '14
New Berlin

Ernest Mast '15
Morgantown

Hilary Schramm '15
Jeannette

Jeffrey Stoltzfus '14
Atglen

John Shenk '14
Littitz

Jonathan Strite '16
Harrisburg

Thomas Strzelecki '15
Wapwalopen

Thomas Styer '15
Muncy

Timothy Weiser '16
York Springs

Executive Secretary
William Troxell
Richfield

Dear Pennsylvania Grower

This special edition of the Pennsylvania Vegetable Growers News, the monthly newsletter of the Pennsylvania Vegetable Growers Association, has been prepared as a source book of information for the Pennsylvania grower. We have listed various vendors of equipment, supplies and services who deal with Pennsylvania growers. Keep this booklet handy to refer to throughout the year.

We also ask you to consider joining the Pennsylvania Vegetable Growers Association. If you are a vegetable, potato or berry grower, you should belong to the organization that represents your industry. Your membership will strengthen the Association's position as the voice of the vegetable, potato and berry industries and will also provide numerous benefits to you.

For example, each year the Association co-sponsors the Mid-Atlantic Fruit and Vegetable Convention in Hershey. This meeting is one of the most respected vegetable meetings on the East Coast and offers three days of concurrent sessions on processing vegetables, fresh market vegetables, potatoes, small fruits, bedding plants, direct marketing, organic vegetables, cut flowers and other specialty crops. As a member of the Association, you help make this convention possible and you receive reduced registration fees. PVGA also sponsors field days at Penn State's research plots, and regional grower meetings.

As a member, you will receive monthly subscriptions to this newsletter, the **Pennsylvania Vegetable Grower News**, to keep you informed on what is happening in the vegetable, potato and berry industries. PVGA members also receive free subscriptions to the **American Vegetable Grower** and the **Vegetable Growers News**.

Last year, the Association gave over \$67 per member of the Association or a total of \$66,200 to Penn State University researchers to sponsor practical vegetable and berry research. This was made possible through the Association's food booths at the Pennsylvania Farm Show and Ag Progress Days. These food booths also help to promote the vegetable and berry products you produce.

PVGA represents the interests of the vegetable, potato and berry industries on both state and federal issues. The Association contacts legislators regularly on issues that affect our growers. Special attention is given to food safety, state budget appropriations, labor, deer crop damage, irrigation (water use), and pesticides as they relate to horticultural growers.

The Association is also a member of the State Council of Farm Organizations, the United Fresh Produce Association and the Penn State Agricultural Council, again with the purpose of representing the vegetable, potato and berry industries in the public arena and to Penn State University researchers and administrators.

The bottom line is this. A \$50 membership in the Pennsylvania Vegetable Growers Association is worth every penny. For each member, about \$67 is given to research, about \$19 is spent to publish the Pennsylvania Vegetable Growers News, and up to \$85 per person can be saved on three-day registration fees for the Mid-Atlantic Fruit and Vegetable. That adds up to \$171 or over triple the return on your dues investment.

Members can also purchase Workers' Compensation and Health Insurance through Agri-Services Agency.

Use the form on page 34 of this newsletter to join today!

The Pennsylvania Vegetable Growers News is the official monthly publication of the Pennsylvania Vegetable Growers Association, Inc., 815 Middle Road, Richfield, PA 17086-9205 phone and fax - 717-694-3596, email - pvga@pvga.org website - www.pvga.org

Our Mission:

The Pennsylvania Vegetable Growers Association serves Pennsylvania's commercial vegetable, potato and berry growers through education, research, advocacy and promotion.

Our Vision:

The Pennsylvania Vegetable Growers Association will be the driving force in ensuring the future viability of the commercial vegetable, potato and berry industries in Pennsylvania.

Inquiries about membership, this publication or advertising rates should be directed to William Troxell, Executive Secretary, at the above addresses.

GENERAL

MID-ATLANTIC *fruit & vegetable convention*



January 27 to 29, 2015

Hershey Lodge and Convention Center – Hershey, Pennsylvania

The Premier Grower Meeting in the Northeast

***Trade Show with over 160 exhibitors
featuring the latest in grower and direct marketing supplies.***

Pre-Convention Workshops & Tour

***January 26 – Farm Market Bus Tour, Farm Food Safety,
Communicating with Consumers and the Media, Organic Growing, Irrigation
Water Toolbox, Pesticide License Training, USDA-AMS Grant Writing***

*Keynote
Speaker*



**Russell
Redding**
Delaware
Valley College

*Human Capital:
Now, Tomorrow
and the Next
Generation*

***Educational Sessions all three days– over 40 sessions
featuring expert speakers from across the nation!!!***

January 27

***Tree Fruit, Tomatoes, Organic Vegetables, Food Trends, CSAs,
Pollinators & Pollination, GMOs, Onions, Leafy Greens, Snap
Beans, Drip Irrigation, Apps for Ag, Labor/Farm Management***

January 28

***Sweet Corn, Peaches, Tree Fruit, Wine Grapes, Marketing 101,
Agritainment, Greenhouse Ornamentals, Small Fruit, Soil
Health/Cover Crops, General Vegetables, Spanish***

January 29

***Small Fruit, Tree Fruit, Vine Crops, Pumpkins, High Tunnels,
Potatoes, Vegetables Post Harvest, New Equipment,
Weed Control in Vegetables***

For information visit www.mafvc.org or call 717-694-3596

Registration fees range from \$65 to \$150.

PVGA members receive substantial discounts. Save more by pre-registering.

Walk-in registration is available – payment by cash or check only.

VENDORS BY CATEGORY

Vendors are listed below by category of the equipment, supplies or services they offer. An alphabetical listing of vendors and their addresses begins on page 27.

General Equipment

Tillage and Cultivating Equipment

Binkley & Hurst Bros. Inc. - 800-414-4705
 Hillside Cultivator - 717-626-6194
 I & J Manufacturing - 717-442-9451
 Market Farm Implement - 814-443-1931
 Messick Farm Equipment - 800-222-3373
 Stauffer Engine and Equipment, Wes -
 717-738-4215
 Woodhouse, J. S. - 717-938-5100

Planting Equipment

Binkley & Hurst Bros. Inc. - 800-414-4705
 Black Rock Repair 717-529-6553
 Hoover Tractor - 570-966-3821
 I & J Manufacturing - 717-442-9451
 Market Farm Implement - 814-443-1931
 Martin's Produce Supplies - 888-381-8641
 Marvel, Robert, Plastic Mulch
 800-478-2214
 Mechanical Transplanter Co.
 800-757-5268
 Messick Farm Equipment - 800-222-3373
 Nolt's Produce Supplies - 717-656-9764,
 661-7069
 Rain-Flo Irrigation - 717-445-3000
 Stand'N Plant - 724-639-3965
 Woodhouse, J. S. - 717-938-5100

MaterMacc Precision Vacuum Planters ***Finally, One Planter For All Seed!***



Plants All Size Seed from
Raw Lettuce to Lima Beans!
Quick Change Row Spacings!
Quick Change Seed Variety!
Quick Fertilizer Clean Outs!
1.5 Thimble Seed Charging!

**Market Farm
 Implement, Inc.**
814-443-1931

www.MarketFarm.com

MaterMacc

Shown with ***easy set*** toolbar,
stainless steel fertilizer
 and ***insecticide*** hoppers, and
 double disc fertilizer opener.

Unmatched Singulation!

MECHANICAL TRANSPLANTER COMPANY

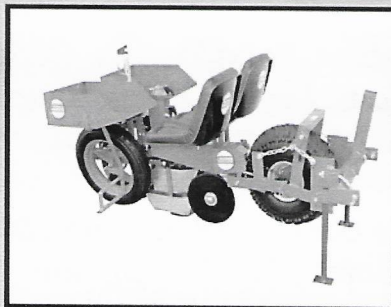

Model 1000

* Excellent for bare root and small cells. Our most popular transplanter.

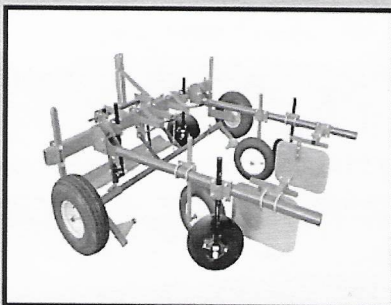

Model 90

* Lays any size mulch from 3-6 feet wide.

NEW CLEAN SEEDER

MODEL JP-1

* Excellent for small seed
 * Lightweight & easy to handle
 * Accurate spacing



MODEL JPH

* Row spacing as close as 7"
 * Mounts on 2" square toolbar

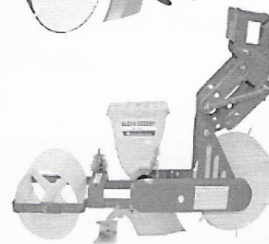

Mechanical Transplanter Company, LLC * 1150 Central Avenue * Holland, MI 49423

Phone: 616-396-8738 or 800-757-5268 * Fax: 616-396-3619

website: www.mechanicaltransplanter.com * e-mail: mtc@mechanicaltransplanter.com



FM750
\$2,995.00
Part #: ZTN94000-20



EZ250
\$1,195.00
Part #: ZTN92000-20



PRO 700
\$4,759.00
Part #: 84546676

AutoPilot
\$4,995.00
Additional Components Required
Part #: ZTN54425-07

Field IQ
Call Guidance Specialist
for details



Master Switch Box
Call Guidance Specialist
for details



Part #: ZTN80800-02

AFS 372
\$3,145.00
Part #: 84588266



FM1000
\$4,995.00
Part #: ZTN933002000



EZ-Steer 250/500
\$2,145.00
Part #: ZTN62000-50



EZ-Steer 750/1000
\$2,345.00
Part #: ZTN62000-52

AccuControl
Call Guidance Specialist
for details



Part #: 84588266

EZ-Pilot
\$3,995.00
Additional Components Required
Part #: ZTN82000-80

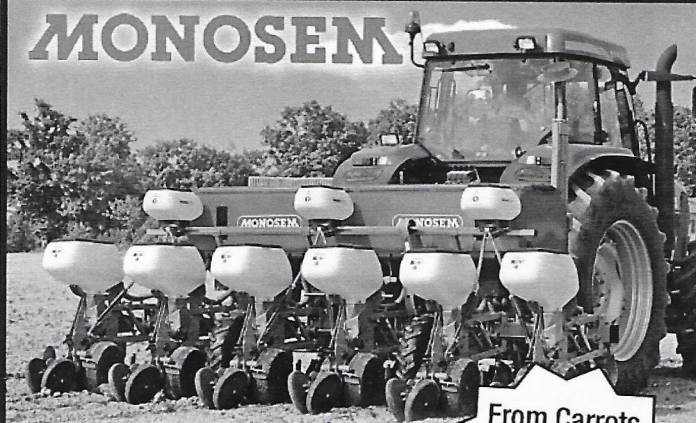

MONOSEM

NG Plus Series
Quality. Versatility. Value.

From Carrots to Fava Beans, the NG Plus Does It All!

Monosem Advantages Add Up:

- 1) Accurate Seed Singulation & Spacing
- 2) Consistent Depth Control
- 3) Good Seed to Soil Contact For Germination

Reap The Benefits of a **MONOSEM**

BNL 3-pt Mounted Sprayers

An excellent choice for use with compact tractors that will enable municipal and industrial turf care professionals easy maneuverability. Simple to mount and operate.

BNL 50 standard equipment includes HARDI 500 diaphragm pump with PTO drive, M70 spray controls and spray gun with 25' of 1/2" hose and hose wrap. An optional 14' horizontal fold boom, HARDI 110° ISO Snap Fit nozzles is available.

Call Us or Visit Today and Let Us Help You Find the Right Hardi Sprayer for Your Operation!



800-414-4705
133 Rothsville Station Road
Lititz, PA 17543

For more information or to explore our full offering of quality new and used agricultural equipment, visit us online at **binkleyhurst.com**

VENDORS BY CATEGORY

General Equipment

Bedders, Bed Shapers, Drain Ditchers, Tool Bars and Accessories

- Market Farm Implement – 814-443-1931
- Nolt's Produce Supplies - 717-656-9764, 661-7069
- Rain-Flo Irrigation - 717-445-3000

Fertilizer Application Equipment

- Market Farm Implement – 814-443-1931
- Mechanical Transplanter – 800-757-5268
- Messick Farm Equipment – 800-222-3373



STAND 'N PLANT

SEEDER **PLANTER**

Use for... *Easily plant hundreds of seeds or plants per hour into plastic covered or bare ground seed beds.*

- Seeds
- Onions
- Garlic

- Transplants
- Potatoes
- Bulbs

Stand 'N Plant
95 Rose Road, Saltsburg, PA 15681
Phone: 724-639-3965 or visit: www.standnplant.com

Be Prepared When The Weeds Start To Grow

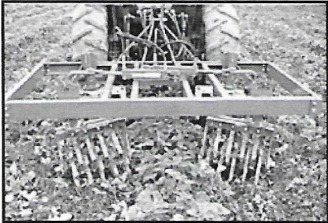

Hillside Cultivator Model CS
← The best cultivator for strawberries and between plastic mulch.



The best cultivator for in row weed removal. → **Eco Weeder**

Hillside Cultivator Co. LLC
911 Disston View Dr., Lititz, PA 17543
717-626-6194 www.hillsidecultivator.com

TOOLS FOR YOUR PLOWING NEEDS!



Cover Crop Rollers
Roll down corn stalks. No till organically. Roll down pastures after grazing.

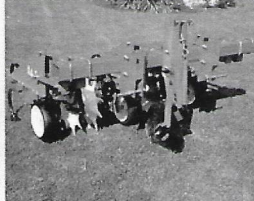

3 PT Cultivators

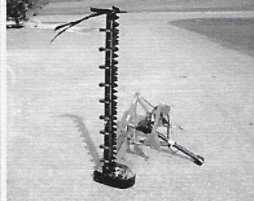

Sickle Bar Mowers
Low torque. Non-plugging.



Cultivators
Horse drawn and 3 PT

I & J mfg. LLC 5302 Amish Road Gap, PA 17527
(717) 442-9451

We also carry:

- Plows
- Hay Rakes
- Tedders
- Ground Drive Forecarts
- Market Garden Tools
- 3 PT Equipment
- Forecarts
- Mowers Can Be Ground Driven

CROP CARE®

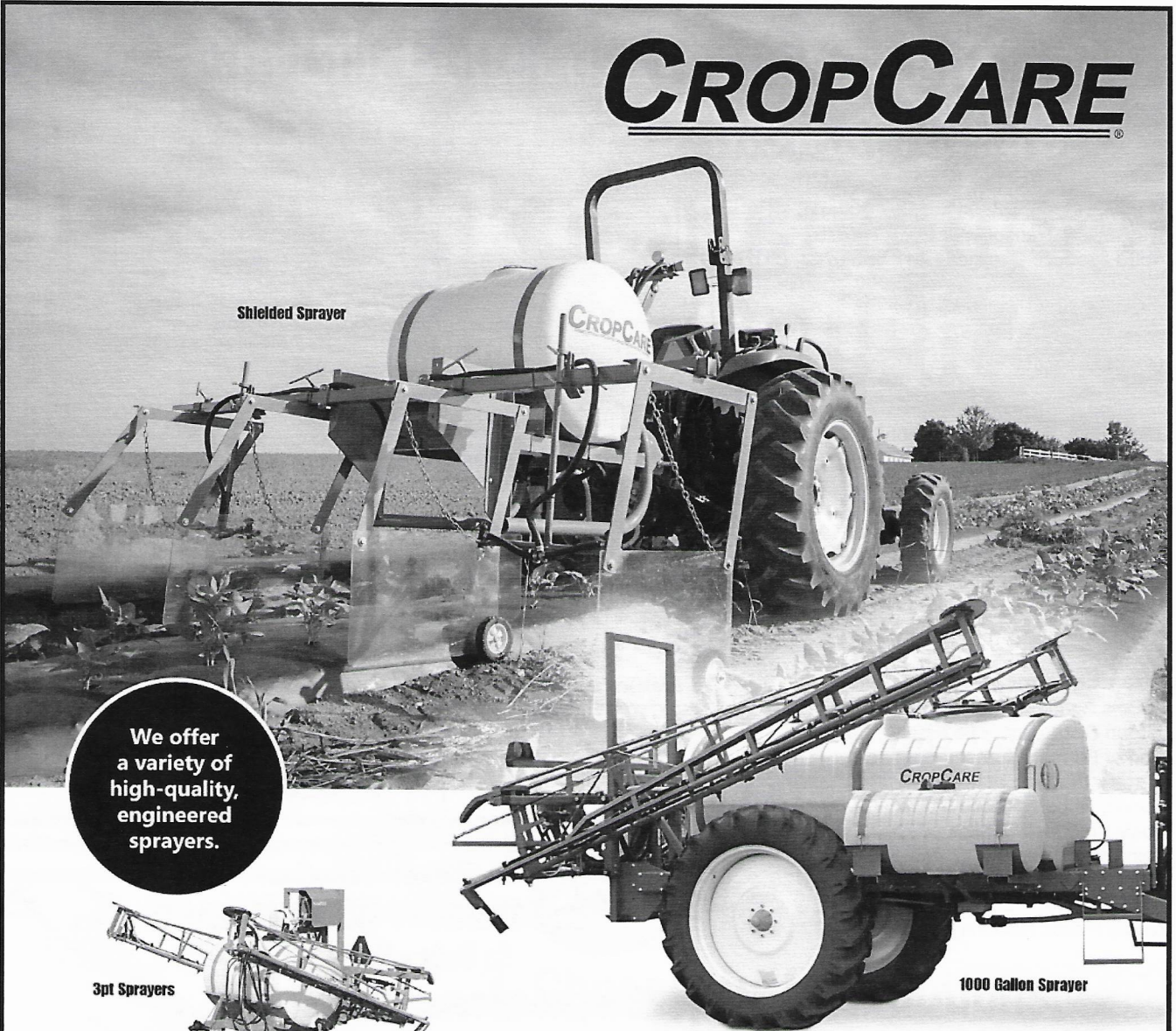

Shielded Sprayer

We offer a variety of high-quality, engineered sprayers.

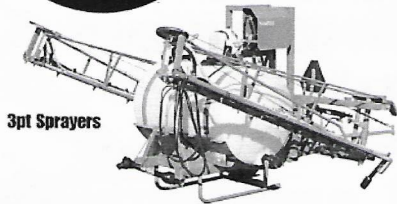

3pt Sprayers



1000 Gallon Sprayer

Experience the quality, Enjoy the results.



Compact/ATV Sprayers



ATX Series



Lawn Sprayers

CropCareEquipment.com | Lititz, PA

Manufactured by PBZ LLC, a Paul B. Zimmerman, Inc. company

Please contact your local CropCare dealer with any questions.

Pennsylvania
Martin's Repair Shop LLC
 Ephrata..... 717-733-3015

Sandy Lake Implement
 Sandy Lake..... 888-252-0656

Cedar Grove Farm Store
 Shippensburg..... 717-532-7571

VENDORS BY CATEGORY

General Equipment

Plasticulture Equipment

Crop Care/PaulB LLC - 717-738-7365
 DuBois Agrinovation - 800-667-6279
 Hoover Tractor - 570-966-3821
 Martin's Produce Supplies - 888-381-8641
 Market Farm Implement - 814-443-1931
 Marvel, Robert, Plastic Mulch - 800-478-2214
 Mechanical Transplanter Co. - 800-757-5268
 Nolt's Produce Supplies - 717-656-9764, 661-7069
 Rain-Flo Irrigation - 717-445-3000
 Saylor's Farm Products - 814-745-2306
 Trickl-Eez Co. - 800-672-4700
 Zook's Plastic Recovery - 717-656-4422

Harvesting Equipment

Black Rock Repair 717-529-6553
 Crop Care/PaulB LLC - 717-738-7365
 Haines Equipment - 607-566-2234
 I & J Manufacturing - 717-442-9451
 Market Farm Implement - 814-443-1931
 Martin's Produce Supplies - 888-381-8641
 Messick Farm Equipment - 800-222-3373
 Nolt's Produce Supplies - 717-656-9764, 661-7069
 Rain-Flo Irrigation - 717-445-3000

Irrigation Equipment and Supplies

DuBois Agrinovation - 800-667-6279
 Jordan Seeds, Inc. - 651-738-3422
 Market Farm Implement - 814-443-1931
 Martin's Produce Supplies - 888-381-8641
 Marvel, Robert, Plastic Mulch. - 800-478-2214
 Nolt's Produce Supplies - 717-656-9764, 661-7069
 Rain-Flo Irrigation - 717-445-3000
 Toro-Microirrigation - 800-333-8125 3-8125
 Trickl-Eez Co. - 800-672-4700
 Zook's Plastic Recovery - 717-656-4422

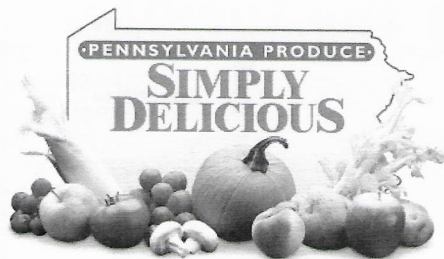

VEGETABLE GROWERS

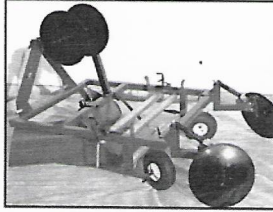

**COMPACT RAISED
BED MULCH LAYER**

- Designed for use in High Tunnels or small fields.
- 3ft. and 4 ft. models. Forms 4" high bed. 25-30 HP required.

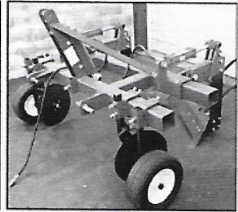

**MODEL 550
HYDRAULIC RESET
MULCH LIFTER**

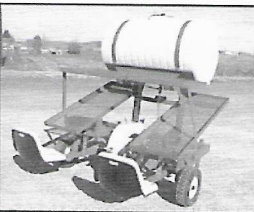

**MODEL P150 WATER
WHEEL PLANTER**

- Total Open Frame
- Easier to change planting wheel
- 3 pt. or pull type

Also Available

- Model 500 Mulch Lifters
- Super Deluxe Flatbed Mulch Layers
- HYD Drive
- Mulch Wrappers

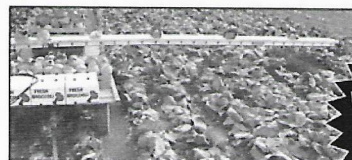

**ALUMINUM HARVESTING
CONVEYORS**

Specializing in
**VEGETABLE GROWING
EQUIPMENT &
SUPPLIES**

**Call for our
commercial growers catalog**

NOLT'S PRODUCE SUPPLIES
 152 N. Hershey Ave., Leola PA 17540
(717) 656-9764

BCS

THE BEST TILLER ON EARTH
 No Belts • No Chains • No Equal

\$100 to \$300 Off Select Models!

- 18" to 30" Tillers
- Models 6 to 13HP Honda Engines
- Quick Change Handle Positions
- No Time-Limit Warranty on Transmissions
- 50% Higher Tine Speed Than Competition
- **FREE** Quick Hitch for Attachments on 732 & 853

FREE
Furrower
with model 715
& 722



Rotary Plow



Brush Mowers



Sickle Bar Mowers



Power Sweepers



Snow Throwers

Also: Flail Mowers • Chipper/Shredder • Wood Splitter • Utility Trailer

WES STAUFFER EQUIPMENT LLC
www.wesstauffer.com 717-738-4215
BCS Dealer For 27 Years!

23 Pleasant Valley Rd. East of Ephrata off Rt. 322 • Mon. & Wed. 8-5:30; Tues., Thur., Fri. 8-7 Sat. 8-3

Rain-Flo Irrigation LLC



*Serving your irrigation needs...
Call today for our free catalog.*



Mfg. of Vegetable Machinery
Sales of Drip Irrigation & Plastic Mulch
Retail ▪ Wholesale



929 Reading Rd
East Earl, PA 17519
PH:717-445-3000
Fax:717-445-8304

VENDORS BY CATEGORY

General Equipment

Pesticide Application Equipment

- A-1 Mist Sprayers – 877-924-2474
- Black Rock Repair 717-529-6553
- Crop Care/PaulB LLC - 717-738-7365
- Danville Industries – 800-662-4212
- Hoover Tractor – 570-966-3821
- Iva Manufacturing – 717-768-0747
- Market Farm Implement – 814-443-1931
- Martin's Produce Supplies – 888-381-8641
- Martin's Repair Shop - 717-733-3015
- Messick Farm Equipment – 800-222-3373
- Penns Creek Welding - 570-837-1197
- Swihart Sales Co. - 800-864-4695
- Woodhouse, J. S. – 717-938-5100



SOLO SPRAYERS

We carry a full line of Solo Sprayers from hand pump to engine driven units. Call us today for your spraying needs.

We ship UPS

PARTS • SALES • SERVICE

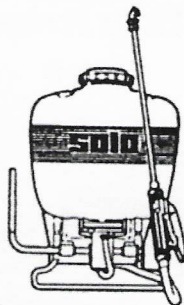
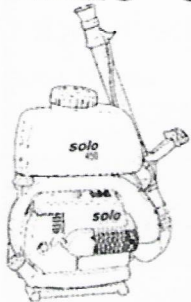

28 East Trout Run Road,
Ephrata, PA 17522
Ph: 717-733-3015



SPECIALIZING IN ONE SIDE BOOM SPRAYERS FOR THE VEGETABLE AND BERRY GROWER

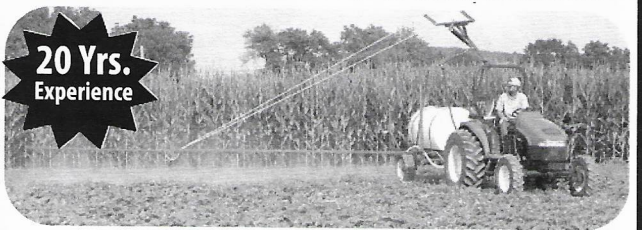

PENNS CREEK MFG.

1340 Broadway Rd., Winfield, PA 17889
1-570-837-1197 www.pennscreekwelding.com

Builders of Dependable Economical Vegetable Sprayers

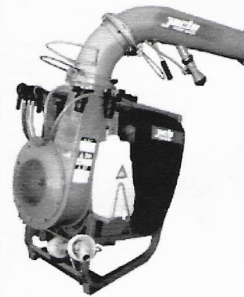

Jacto cannon sprayers provide increased coverage in dense foliage and broadleaf crops such as pumpkins, sweet corn, tomatoes and strawberries. 7 different models available to fit every size farm and crop combination. Also works great in blueberries and raspberries to combat the spotted wing drosophila.

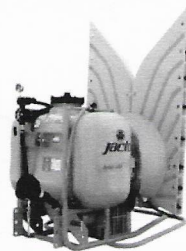

Jacto airblast sprayers come in 9 different sizes from 50 to 1000 gallons. Including 4 models with towers for increased efficiency in dense vertical crops such as grapes, blueberries and Christmas trees. Three models can be safely operated with 20HP tractors.



Jacto backpacks are ergonomically designed for ease of operator use and comfort. These backpacks are ideal for the smaller grower who does not want to use a tractor mounted sprayer or for use in cold frames, greenhouses and spot spraying. 4 models to choose from including two with paddle agitation for wettable powders such as Surround.

For more information or the name of your local dealer contact JS Woodhouse

J.S. Woodhouse Co., Inc. Since 1843
WOODHOUSE
email: info@jswoodhouse.com
www.jswoodhouse.com

J.S. WOODHOUSE CO., INC
Serving: PA, DE, MD, NJ, NY & New England
West Springfield, MA • 413-736-5462
Syracuse, NY • 315-463-5201
Lewisberry, PA • 717-938-5100
Fairfield, ME • 207-453-7788

MESSICK'S
A Helping Hand With Your Land

NEVER LOOK BACK!



NEW HOLLAND
AGRICULTURE



GUARDIAN FRONT BOOM SPRAYERS

- 240-365 HP • 1000-1600 Gallon Capacity
- Full 6' Crop Clearance for Late Season Fungicide Applications
- Tight Turning Radius • Superior Operator Visibility
- Superior Boom and Operator Ride • Try Front Boom and Never Look Back

SP.240F

MESSICK'S
A Helping Hand With Your Land

Abbottstown
7481 Lincoln Highway

Elizabethtown
187 Merts Drive

Halifax
3882 Peters Mtn Rd

800.222.3373 • www.messicks.com

MLMF-14-119094-2

VENDORS BY CATEGORY

General Equipment**Grading, Packing and Storage Equipment**

Black Rock Repair 717-529-6553
 Haines Equipment – 607-566-2234
 Market Farm Implement – 814-443-1931
 Martin's Produce Supplies – 888-381-8641
 Nolt's Produce Supplies - 717-656-9764, 661-7069
 Rain-Flo Irrigation - 717-445-3000
 Tew Manufacturing Corp. – 800-380-5839

**Refrigeration Equipment**

Arctic Refrigeration - 585-343-2678
 KoolJet Refrigeration - 866-748-7786

General Supplies**Fertilizer**

Blackmore Co. – 800-874-8660
 CSI Chemical – 800-247-2480
 Daniel's Farm Store – 717-656-6982
 Martin's Produce Supplies – 888-381-8641
 Nolt's Produce Supplies - 717-656-9764,
 661-7069
 Oregon Ag – 717-656-0067, 717-284-7106
 Perdue AgriRecycle – 302-628-2361
 Plant Food Co. – 800-562-1291
 Timac Agro USA - 800 545 5474
 Trickle-Eez Co. - 800-672-4700
 USA Gypsum – 717-335-0379

Pesticides/Plant Growth Regulators

Daniel's Farm Store – 717-656-6982
 Martin's Produce Supplies – 888-381-8641
 Oregon Ag – 717-656-0067, 717-284-7106

Biocontrols – Beneficial Insects

IPM Laboratories - 315-497-2063

Wildlife/Bird Damage Control Products

DuBois Agrinovation – 800-667-6279
 JWB Marketing – 800-555-9634

Mulching/Row Covers

DuBois Agrinovation – 800-667-6279
 Gristmill Vegetable Farm – 717-354-8444
 Harris Seeds – 800-544-7938
 Jordan Seeds, Inc. - 651-738-3422
 Martin's Produce Supplies – 888-381-8641
 Marvel, Robert, Plastic Mulch
 800-478-2214
 Mechanical Transplanter Co.
 800-757-5268
 Nolt's Produce Supplies - 717-656-9764,
 661-7069
 Rain-Flo Irrigation - 717-445-3000
 Schwartz & Sons – 800-523-3500
 Trickle-Eez Co. – 800-672-4700
 USA Gypsum – 717-335-0379

Black Rock Repair LLC

Manufacturer of farm and home sprayer

sprayer pumps parts & service | pressure washer sales & service

LEROY or LEVI • 717.529.6553

hydraulic hoses | general welding & repair
 produce equip | UPS service | sprayer manufacturing



Call for prices

858 Pumping Station Rd | Kirkwood, PA 17536

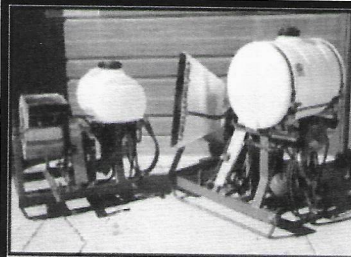

SWIHART
 Sales Company
 – Mist Sprayers –

SPRAY
 INNOVATIONS

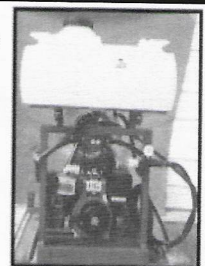

Motor Models
 available

American Made

We offer a complete line of low volume mist blowers.

Low Maintenance
 High Performance

Excellent for spraying:
 VEGETABLES, vineyards,
 orchards, nurseries, Christmas
 trees, mosquitoes, cattle,
 chicken houses, etc.

References
 available in
 your area

For free brochure contact:

Swihart Sales Co.

7240 County Road AA, Quinter, KS 67752

785-754-3513 or 800-864-4595

www.swihart-sales.com



Grown in PA. It makes a difference.

ROBERT MARVEL PLASTIC MULCH, LLC

Plastic Mulch Film

Embossed, Smooth and Biodegradable.

Greenhouse Cover

Solaroof Woven Greenhouse Cover. Tufflite IV - 6 mil., Tufflite IR - 6 mil.

Equipment

Plastic Mulch Layers, Plastic Mulch Lifters, and Planters.

Floating Row Covers

Earlier Harvest, Insect Protection and Frost Protection. Also Available in Custom Made Sizes to Fit your Fields.

Drip Irrigation

Carrying a Full Line Of Drip Irrigation Tapes, Filters, Pressure Regulators, Fittings, In-Line Drip Tube and More.

Avian Control

The Most Effective Liquid Bird Repellent Available.

www.robertmarvel.com OR Call Toll Free 1-800-478-2214

We accept Visa, Mastercard and Discover

TORO.

Count on it.

Aqua-Traxx®
with the PBX Advantage

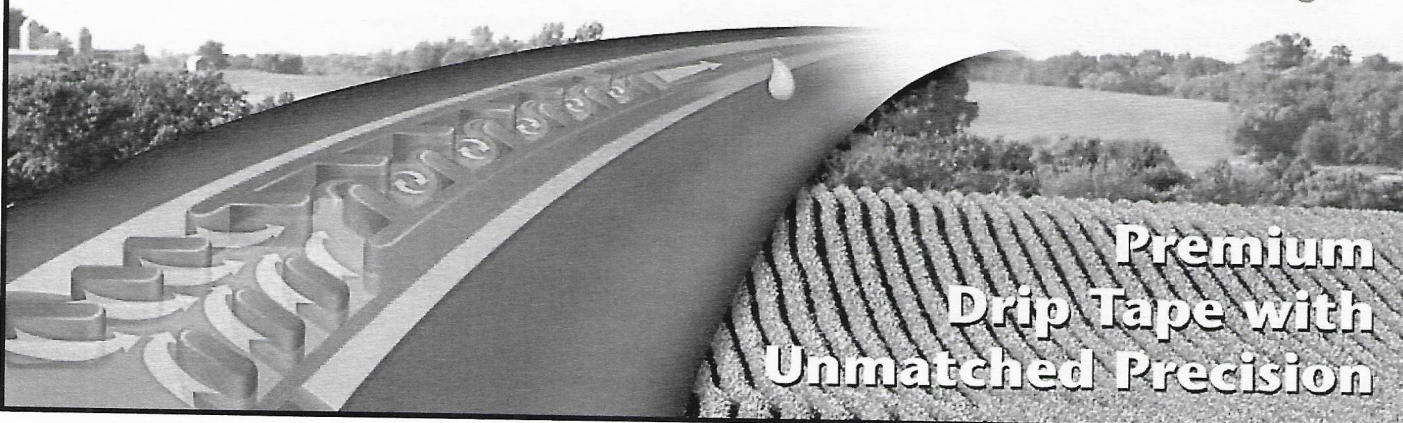

**Premium
Drip Tape with
Unmatched Precision**

VENDORS BY CATEGORY

General Supplies

Containers and Packaging Supplies

- Blackmore Co. - 734-483-8661
- DuBois Agrinovation - 800-667-6279
- International Paper - 800-222-8984
- Jordan Seeds, Inc. - 651-738-3422
- Martin's Produce Supplies - 888-381-8641
- Nolt's Produce Supplies - 717-656-9764, 661-7069
- ProducePackaging.com - 800-644-8729
- Putnam Plastics - 800-457-3099
- Saylor's Farm Products - 814-745-2306
- Zook's Plastic Recovery - 717-656-4422

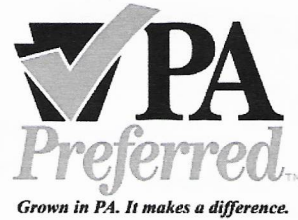

KOOLJET®

Reliable Refrigeration Systems

1-866-748-7786 www.kooljet.com

One-Piece and Portable Skid-Mount Systems; Hydro-Coolers; Medical and Process Chillers; Blast Freezers, Vacuum Coolers, Refrigerated Dehumidifiers.

Custom Built Designs - Domestic and International Markets



Visit our website to view our complete line

Refrigerated and Ventilated Cooling Systems for Fruit and Vegetable Storages

- COMMERCIAL REFRIGERATION
- DESIGN, SALES AND SERVICE
- SERVING AGRICULTURE FOR OVER 60 YEARS

**Free Consultation and Quote
Call Mike Mager at 585-343-2678**

See Us At Booth #78 At The Mid-Atlantic Fruit & Vegetable Convention

ARCTIC

REFRIGERATION CO. OF BATAVIA

26 Cedar Street, Batavia, NY 14020
www.arcticrefrigeration.com

3 IN 1 SOIL CONDITIONERS

Ideal For High Speed Cultivation

Perfect for nurseries, berry growers, orchards, vineyards and general cultivation work.

FEATURES:

- 3 soil conditioning tools in one machine
- Heavy-duty 20" high clearance S-Tines to penetrate and till up to 7" deep
- 6-1/2" shank spacing on all models except 4' soil conditioners which have 7-1/3" spacing
- 7" sweeps are standard optional 1-3/8" reversible points
- Spring loaded, 12" diameter rolling crumblers with serrated bars angled to finish mulching the soil

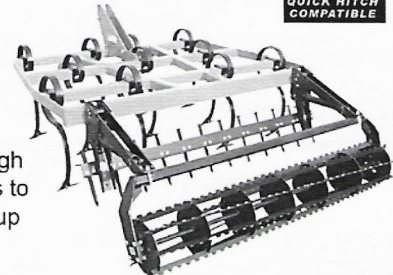

QUICK HITCH COMPATIBLE



Distributed by ~ J.S. Woodhouse Co., Inc.
Phone: (413.736.5462 Fax: (413.732.3786
www.JSWoodhouse.com

VENDORS BY CATEGORY



ProducePackaging.com[®]
for all your produce packaging needs

1-800-644-8729
 Kurt Zuhlke & Assoc., Inc.
 P.O. Box 609, Bangor, PA 18013

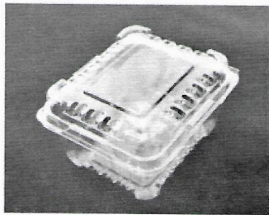

Over 45 Years In The Industry

For over 45 years, Kurt Zuhlke & Assoc., Inc. has been a part of the many innovative packaging concepts utilized by the produce industry.

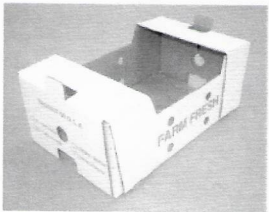

High Quality Products And Services

Our packaging is designed to protect produce, provide excellent visibility to the consumer, reduce shrinkage and enhance the product. We also offer professional labeling design and application.

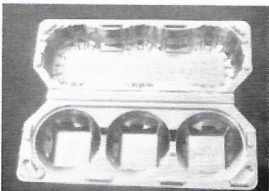

From Farmers To Repackers

Whether you are ordering a case or a truck load, you can rest assured that we have the ability and capacity to service your orders quickly.



Floating Row Cover 2015 Stock Sizes

.56 oz. per sq. yd.	.91 oz. per sq. yd.
7'x500'	7'x800'
7'x1000'	14'x800'
10'x500'	26'x800'
14'x1000'	39'x800'
22'x1000'	42'x500'
26'x1000'	50'x500'
30'x1000'	
36'x1000'	1.25 oz. per sq. yd.
40'x1000'	50'x500'
50'x500'	and custom sizes

- ✓ Quality Cover
- ✓ Discount Prices
- ✓ Trailerload Quantities in Stock

Clip & Save



Gristmill Vegetable Farm
 201 Gristmill Rd., New Holland PA 17557
 Phone /Fax 717-354-8444

Bluefire row cover on strawberry crop

Clip & Save

VENDORS BY CATEGORY

Direct Marketing Supplies

Baskets

Putnam Plastics – 937-866-6261

Farm Market Packaging

Putnam Plastics – 937-866-6261

Promotional Materials

PA Veg. Mktg. & Research Prog. – 717-694-3596



microSTART60®

Guaranteed Analysis
3-2-3

Whether you grow 100% organically or conventionally, **microSTART60** fertilizers are the perfect fit for your nutrient management program.

- Up to 60% organic matter for continued performance and profit
- High Humic Acid Value – up to 5%!
- Extremely Low Salt Index – less osmotic pressure, better nutrient uptake
- Significant Slow Release WIN Value
- *Pasteurized*, Pathogen Free, Weed Free
- Listed for **UNRESTRICTED** use in organic crop production by the Organic Materials Review Institute (OMRI) and National Organic Program (NOP) Compliant
- Safe to apply around people and pets
- Micro-element package includes Magnesium, Iron, Sulfur, Manganese, Copper, Zinc, Calcium for improved cell structure
- Consistent Quality and Nutrient Values of 3-2-3 NPK
- Improves Soil Performance, Moisture Retention and Tilth
- Less than 12% Moisture Content
- Encourages Microbial Activity and Cation Exchange while Repressing Leaching

Typical Nutrient Analysis

Nitrogen	3.80%
Insoluble N	2.10%
Soluble N	1.70%
Phosphorus (P205)	2.20%
Potassium (K20)	3.50%
Calcium	2.50%
Sulfur	0.76%
Magnesium	0.50%
Copper	0.05%
Zinc	0.05%
Manganese	0.05%
Iron	0.05%
Humic Acid up to	5.40%



PERDUE®
AGRIRECYCLE™, LLC

Call Today!
1.888.268.2988

or visit
www.PerdueAgriRecycle.com

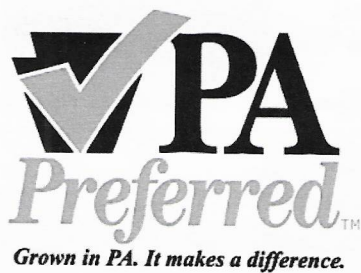



Saylor's Farm Products

*Builders Of All Kinds Of
Small Boxes and Bins*

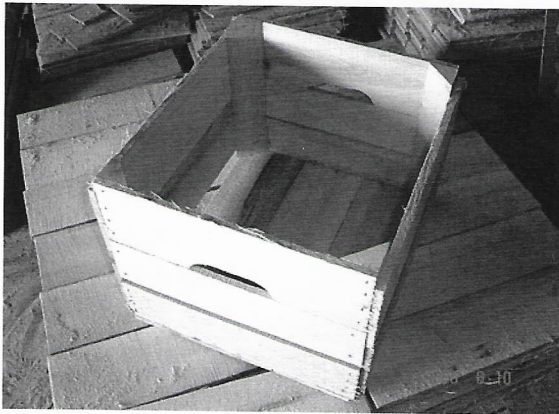

Manufacturers of Agricultural Containers.
www.saylorfarm.com



Saylor's Farm Products

17319 Route 68, Sligo, PA 16255
Phone 814-745-2306
john@saylorfarm.com

TEW MANUFACTURING CORP.

**Fruit & Vegetable Cleaning & Sizing
Equipment**

**Quality Latex & Poly Sponge
Drying Donuts**

**Tuff Foam® Protective Padding
Brushes, Bearings, Sizing Chains
Scrubber Rubber Plain & Fabric Back**

**Stanhay, Tew Jr.™, Tew Mx™
Vegetable Seed Planters & Parts**

**FOR MORE INFORMATION CALL
1-800-380-5839**

TEW MFG. CORP.

P.O. BOX 87

PENFIELD, NY 14526

585-586-6120

FAX: 585-586-6083

www.tewmfg.com

**Putnam
Plastics**
FARM PRODUCTS

**Packaging
Solutions**

- Plastic Containers
- Paper, Poly & Mesh Bags
- Fruit & Vegetable Picking Containers
- Corrugated & Gift Packaging
- Wood Baskets
- Cider Jugs
- Labels
- Bin Liners
- Custom Printing Available

for any season



Ask for a
Free Catalog



1.800.457.3099

FAX: (937)866.9365 www.putnamfarm.com

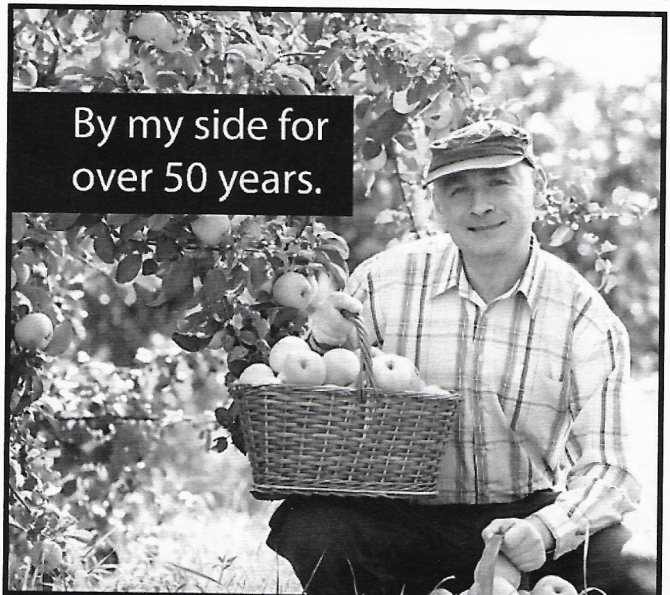

By my side for
over 50 years.

Rockford handles all of
my packaging needs.

See you at the
Mid Atlantic Show!
(800) 444-PACK

www.rockfordpack.com

rockford
package supply

VENDORS BY CATEGORY

Greenhouse Supplies & Equipment

Bedding Plant Seeds/Plugs/Cuttings

- Harris Moran Seeds – 209-579-7333
- Harris Seeds - 800-544-7938
- Stokes Seeds – 800-263-7233
- Twilley Seeds – 800-622-7333

Greenhouse Equipment and Supplies

- A-1 Mist Sprayers – 877-924-2474
- Blackmore Co. - 800-874-8660
- DuBois Agrinovation – 800-667-6279
- IPM Laboratories - 315-497-2063
- Keen Green – 717-389-5992
- Martin's Produce Supplies – 888-381-8641
- Martin's Repair Shop - 717-733-3015
- Marvel, Robert, Plastic Mulch - 800-478-2214
- Nolt's Produce Supplies - 717-656-9764, 661-7069
- Rimol Greenhouse Systems - 603-494-5775
- Trickl-Eez Co. – 800-672-4700
- Tunnel Tech – 855-888-8663
- USA Gypsum – 717-335-0379
- Zook's Plastic Recovery - 717-656-4422

Greenhouse and Low/High Tunnel Structures

- Rimol Greenhouse Systems - 603-494-5775
- Tunnel Tech – 855-888-8663

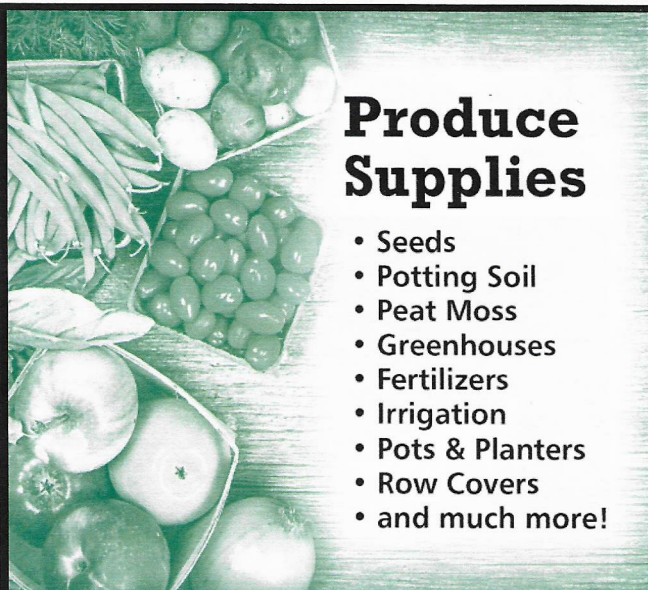

Produce Supplies

- Seeds
- Potting Soil
- Peat Moss
- Greenhouses
- Fertilizers
- Irrigation
- Pots & Planters
- Row Covers
- and much more!

Call now for your Free 2014 Catalog!

1.888.381.8641
(717) 532-5918



627 Britton Rd, Shippensburg, PA 17257

Visit us online: www.MartinsProduceSupplies.com

Your Source for . . .

HIGH TUNNELS

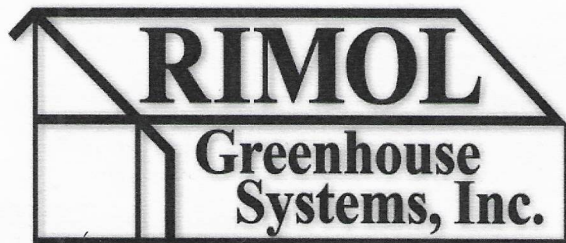

Call Bob Rimol @ 603.494.5775

or Email: rrimol@rimol.com

BLACKMORE TRAYS GET YOU GROWING



Blackmore 98 SQ



EllepotTM make planting melons easy!

Plug trays for every application

- | | |
|-----------|------------------------------|
| 36 | 392 - new |
| 50 | 406- rib |
| 72 | 512 |
| 84 | 648 |
| 98 | 800 |
| 102 | |
| 105 | Punch 'n Gro TM |
| 128 | 288, 324, 432, |
| 144 | |
| 162 | |
| 200 | 20 Row Strip |
| 207 - new | |
| 209 - new | |
| 216 | Paks & Flats |
| 242 | |
| 288 | |
| 338 | Color pictures on web |
| 384 | |



Blackmore Company Inc.

10800 Blackmore Avenue, Belleville, MI, USA 48111
USA/Canada (800) 874-8660 Int'l (734) 483-8661 Fax (734) 483-5454
blackmoreco.com

VENDORS BY CATEGORY

Small Fruit Supplies

Berry Nurseries

- A-1 Mist Sprayers – 877-924-2474
- Krohne Plant Farm – 269-424-5423
- Maplewood Produce Greenhouse – 717-732-3278
- Martin's Repair Shop - 717-733-3015
- Nourse Farms, Inc. - 413-665-2658

Since 1932

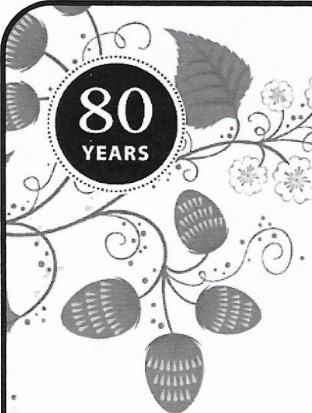

The
**Best
Berry
Plants**

- Strawberries, raspberries, blueberries, blackberries, asparagus and more!
- Where the pros go for plans and plants.
- Call for a free catalog and plasticulture guide!

41 River Road
South Deerfield
Massachusetts 01373

NOURSE

www.noursefarms.com 413.665.2658

Strawberry Plants
Over 20 Leading Varieties • Fall Dug
State Inspected - Grown on Fumigated Sand

Asparagus Crowns
Leading Varieties • Male Hybrids • Superior Root Systems



Over 20 Years Experience
All Available In Our Free
Illustrated Price List
Krohne Plant Farms
65295 CR 342, Hartford, MI 49057
Ph: (269) 424-5423
Fax: (269) 424-3126
www.krohneplantfarms.com

e-mail: info@krohneplantfarms.com

The NUTRI-CAL® Difference
"UNLOCKING THE KEY TO CALCIUM"

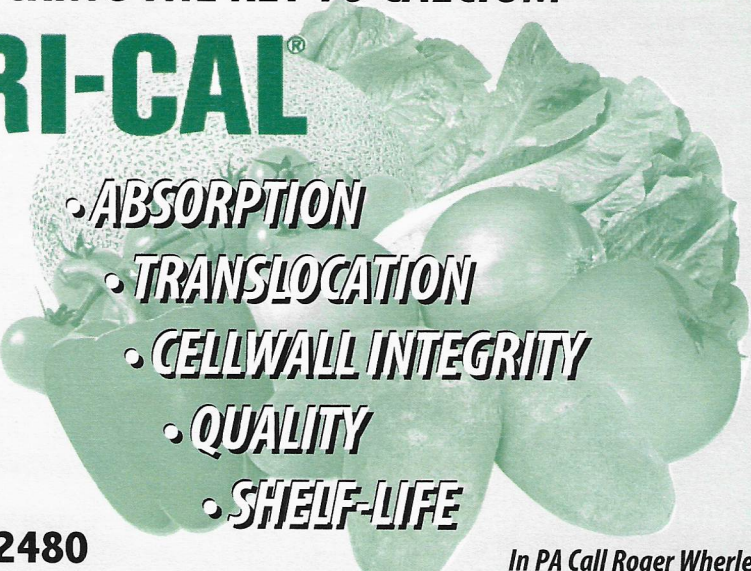
- ABSORPTION
- TRANSLOCATION
- CELLWALL INTEGRITY
- QUALITY
- SHELF-LIFE

Make Sure You Always Ask For
NUTRI-CAL

CALL (800) 247-2480

In PA Call Roger Wherley
717-334-6129

Log on to www.nutri-cal.com

**"ACCEPT NO SUBSTITUTES"
ALWAYS ASK FOR NUTRI-CAL®**

VENDORS BY CATEGORY

Vegetable Supplies

Vegetable Plants

Martin's Repair Shop - 717-733-3015
Seiger's Seeds - 800-962-4999

Vegetable Seeds

Harris Moran Seed Co. - 209-579-7333
Harris Seeds - 800-544-7938
Martin's Produce Supplies - 888-381-8641
Johnny's Selected Seeds - 877-546-6697
Jordan Seeds, Inc. - 651-738-3422
Nolt's Produce Supplies - 717-656-9764
Reed's Seeds - 607-753-9095
Rupp Seeds - 419-337-1841
SeedWay - 800-952-7333
Siegiers Seed Co. - 800-962-4999, 616-786-4999
Stokes Seeds - 800-263-7233
Twilley Seeds - 800-622-7333

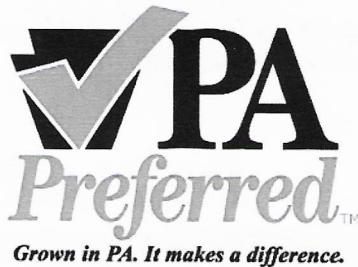

REED'S SEEDS

CABBAGE SEED SPECIALISTS - SINCE 1909

SUPERSTAR

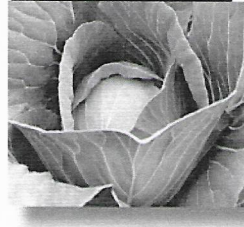

This is a very high quality, fancy mid-season fresh market hybrid green cabbage. It has excellent holding ability in the field and after harvest. SuperStar has excellent flavor and is Yellows Resistant.

GRAND VANTAGE

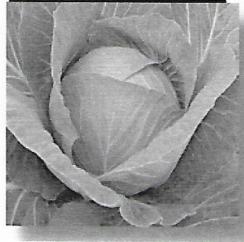

Uniform, very dense head with excellent holding ability and dark green color. About 7 - 10 days earlier than SuperStar and makes an excellent companion variety.

write or call for our Free Catalog.

Reed's Seeds

3334 NYS Route 215 - Cortland, NY 13045
Phone: (607) 753-9095 - Fax: (607) 753-9511

SEEDWAY

Make it a harvest to look forward to!

Quality Seed, Quality Service

SEEDWAY Vegetable Seeds www.seedway.com 800-952-7333

**Deli-King** pickle

- Strong ability to hold color and quality throughout multiple harvests.
- Strong plants for reliable yields.
- Disease resistance includes intermediate resistance to WMV, PRSV and ZYMV.

**Blanco** pumpkin

- Specialty white pumpkin.
- 4-7 lbs.
- Holds bright white color well.
- Strong healthy plant offers good fruit cover late into the season.
- IR:PM.

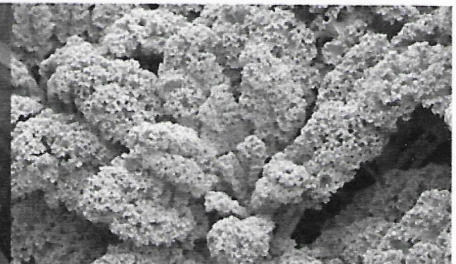
**Starbor** kale

- Hybrid for easy bunching; stems are of even length and ready for bunching.
- Compact plant; strong yields.
- Adapted to both cold and heat! Shows good bolt tolerance and also good cold tolerance.

Our experienced representatives can help you!

Jim Cicalese 717-363-0755 • Pat Licciardello 716-570-1871

STOKES® SEEDS

Sales Team Identifying New Gourmet Sweet™ Brand Varieties

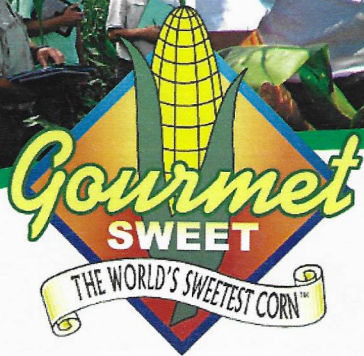

The Leader in High Quality Sweet Corn



**Gourmet Sweet™ Brand
Vision MXR**
75 day yellow



**Gourmet Sweet™ Brand
Anthem XR**
73 day bicolor



**Gourmet Sweet™ Brand
Awesome XR**
76 day bicolor



**Gourmet Sweet™ Brand
2472 XR**
71 day bicolor

Tom Pagels
NJ, PA, DE, MD, VA, LI
856-692-9378

George Dobson
New York, MA, CT
585-734-7214

Karen Grybko
NH, VT, ME, MA, RI
603-654-5362

Keith Peterson
MI, OH, IN, IL
517-626-6065

Tom Dauria
NJ, PA, DE, MD, VA, WV, LI
908-489-4896

Carol Korey
New York
845-651-3553

Randy DeMay
New York
315-483-2080

Ken Wagner
Midwest
317-409-3445

— Quality Seed Since 1881 —

T: 1-800-263-7233 | F: 1-800-272-5560 | www.StokeSeeds.com | Box 548 Buffalo NY 14240-0548

Siegers...more than seed

Our extensive selection and consultant's knowledge of varieties benefits you, our valued customer.



GLACIAL

A 76 day with incredible, bright, white kernels that stay white! Big ears with excellent tip fill. Great eating quality.



SNACK PACK

Resist./Tol.: E1Ht1^(R) PsRp1D^(R)
A 78 day bi-color with incredible eating quality, good husk protection and flags.



ACES

Resist./Tol.: E1Ht1^(R) PsRp1G1^(R)
78 day consistent performer. Great eating quality, tenderness and excellent yield potential.



MIRAI 315BC

A 75 day bi-color with superb eating quality, tender and sweet kernels, strong tip fill, and very refined ears. Produced on sturdy and clean plants.

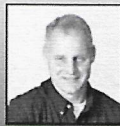

Blake Myers
(585) 303-3252
vegetableseeds@aol.com

1-800-962-4999 • www.siegers.com



Your seed source for outstanding vegetables



For LOCAL FRESH PRODUCE Professionals

Request your free catalog today:

800-622-7333 www.twilleyseed.com 121 Gary Rd., Hodges, SC 29653



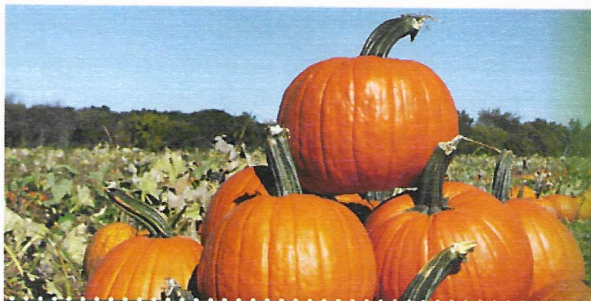

Rhea

This beautiful, consistent-yielding and broadly-adapted pumpkin has a large, dark, firmly attached handle, dark orange color and well-defined ribs. Excellent pumpkin for roadside and shipping!

Warty Goblin

This frighteningly cool heavily-warted hardshell pumpkin has a very high yield, intermediate resistance to Powdery Mildew and warts that stay green long after harvest. Perfect for patches and roadside stores!

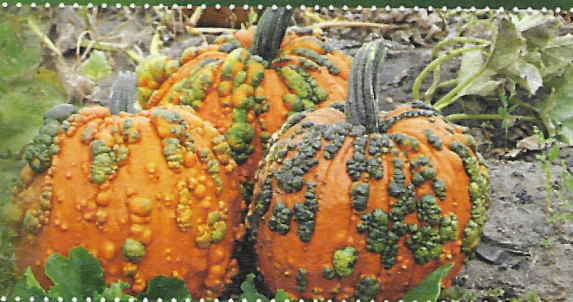

Respect

This high-quality medium dark green zucchini has a vigorous and open plant for easy picking, good earliness, a high yield of top-grade fruit and a good resistance package.

Red Deuce

This fresh market, determinate, round tomato features extra-large uniform smooth fruit with exceptional quality. The medium vigor plant offers good foliage cover, and the early high-yield is perfect for vine ripe harvest.



For more information, call:
Nolts Produce Supply • (717) 656-9764
152 North Hershey Avenue, Leola, PA 17540-9711

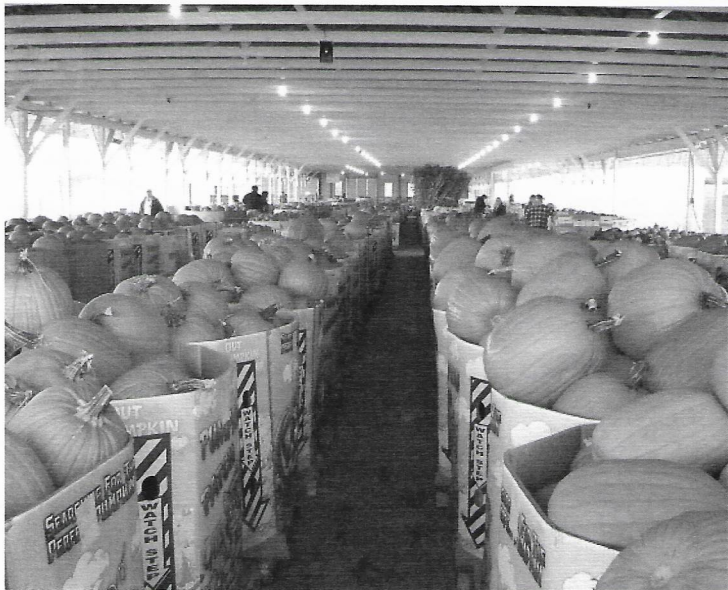

Bins of pumpkins at Buffalo Valley Produce Auction in Mifflinburg.



JORDAN SEEDS, INC.

6400 Upper Afton Rd.
Woodbury, MN 55125

Phone: (651) 738-3422
(651) 739-9578
Fax: (651) 731-7690

www.jordanseeds.com
seeds@jordanseeds.com

- Bulk Vegetable Seed
- Drip Irrigation Tape & Fittings
- Transplanters
- Plastic Mulches, Layers, & Planters
- Row Covers
- Bags, Baskets, Cartons
- Plastic Containers
- Soiless Mix & Seedling Trays
- Soluble Fertilizer

Catalog Upon Request

International Paper offers Innovated Solutions to Vegetable Growers & Packers

International Paper is a packaging leader in the Produce Industry due to our diverse product line, excellent customer service, strategic locations and knowledgeable sales team.

We offer a complete packaging line for Tomatoes, Cukes, Peppers and more.

Our One-Stop-Shopping Line includes:

- Vegetable/Tomato cartons
- Berry shippers
- Bulk Melon bins
- Pint/Quart tills
- Paper/Poly bags
- Staples and accessories

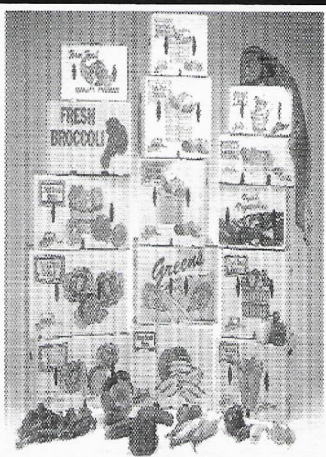

Progressive Packaging for the Agri-Industry

INTERNATIONAL PAPER

342 East York Street
Biglerville, Pennsylvania 17307
Phone 717.677.6111 800.222.8984
Fax 717.677.4394



Sweet corn display at Brook Lawn Farm in Lancaster.

GOOD IS
plentiful.

Visit our booth
at the 2015 Mid-Atlantic
Fruit and Vegetable
Convention.

SOLID GOLD



MOMENTUM

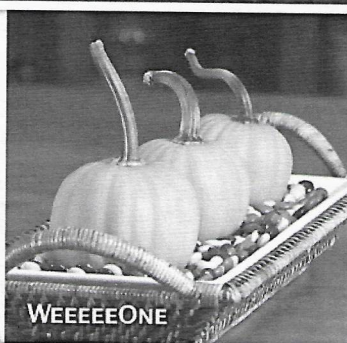

WEEEEEONE

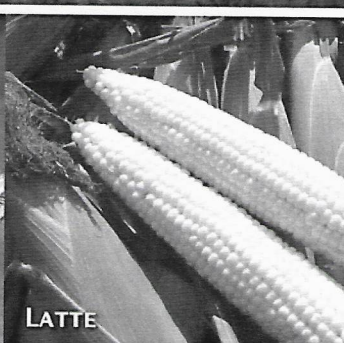

LATTE

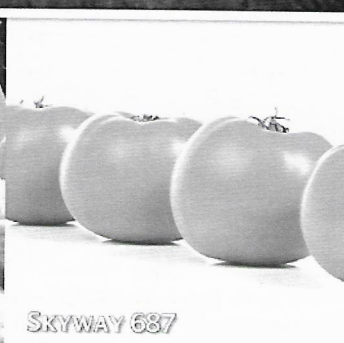

SKYWAY 687

Rupp carries a wide range of vegetable seed, literally from A-Z. No matter what you're looking for – maturity, size, convenience, flavor or that perfect dark orange pumpkin with large handles – you'll find it. And, plentiful applies to more than our selection of seed. Our premium varieties deliver plenty of grower satisfaction as well. We like to say, we deliver unbelievable results made believable.

Call us today and a member of our team can help you select the perfect products or request a copy of our 2015 Vegetable Catalog.

This season, plant Rupp. See What Good Yields®

 Like us on facebook.
www.facebook.com/ruppseedsinc

SEE WHAT GOOD YIELDS®
800-700-1199 · ruppseeds.com



VENDORS BY CATEGORY

Services**Associations**

Pennsylvania Association for Sustainable Agriculture –
814-349-9856
Pennsylvania Vegetable Growers Association –
717-694-3596

Auctioneers

Pirrung Auctioneers – 585-728-2520

Crop Insurance

Morrissey, Bernard, Insurance – 800-422-8335

Financial Services

AgChoice Farm Credit – 800-998-5557
MidAtlantic Farm Credit – 888-339-3334

General Insurance (Liability, Workers Compensation, Health, Fire, etc.)

Agri-Services Agency – 800-256-4105
Morrissey, Bernard, Insurance – 800-422-8335

Government

Pennsylvania Department of Agriculture – 717-705-9511

Produce Auctions

Buffalo Valley Produce Auction – 570-966-1151
Countryside Produce Auction – 814-662-2222
Cumberland Valley Produce Auction – 717-530-5007
Kutztown Produce Auction – 610-683-7161
Lebanon Produce Auction – 717-367-8379
Leola Produce Auction – 717-656-9592
Morrison's Cove Produce Auction – 814-793-9384
Oxford Produce Auction – 610-392-2722
Shippensburg Produce Auction - 717-532-5511
Smicksburg Produce Auction -
Snyder County Produce Auction – 570-374-0284
Sugar Valley Produce Auction – 570-725-2000
Sunnyburn Produce Auction – 717-862-3010
Tri-County Produce Auction – 724-946-8540
Weaverland Produce Auction – 717-355-0834

Sales/Brokerage Services

Seminole Produce Distributing – 717-525-8372

VEGETABLE FARM EQUIPMENT
AUCTION SPECIALISTS
PIRRUNG AUCTIONEERS, INC.
JAMES P. PIRRUNG

P.O. Box 607
2731 East Naple Street • Wayland, New York 14572
www.pirrunginc.com
585-728-2520

"Serving the Buying - Selling Needs of Farmers
Across America Since 1948"

**Multivator
Cultivators**

A **MULTIVATOR** is a high-clearance rotary tillage machine designed for inter-row cultivation of vegetable, nursery, fruit & field crops. Mounted on 3 pt. hitch of tractor & powered by the PTO, it transmits power to a selected number of rotary tiller heads equipped with blades that cultivate ground between rows of growing crops. Weed growth is eliminated & crusted or compacted soils are transformed into tilth.

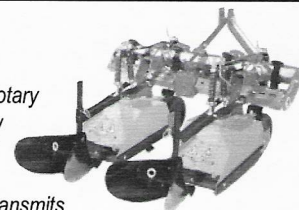

Distributed by:

J.S. Woodhouse Co., Inc. Since 1843

WOODHOUSE

572 Industrial Dr., Lewisberry, PA 17339

717-938-5100 • Fax: 717-938-8769

www.jswoodhouse.com • email: info@jswoodhouse.com

We Recycle

Used Agricultural & Horticultural Plastics**We Buy the Following Materials:**

- ◆ Horticultural Plastic Containers, NO Pesticide Jugs
Prefer Sorted as #2 HDPE, #5 PP, #6 PS.
 - ◆ Clear and White #4 LDPE Greenhouse, High Tunnel and Hoophouse Covers
 - ◆ Polycarbonate and Acrylic (PMMA) Twinwall Structural Panels from Greenhouses
 - ◆ Polycarbonate Corrugated (Dynaglas) sheets
 - ◆ Rigid Plastics: Benches, Trays, Triple-rinsed Drums, Plastic Pallets, Clean Tanks, etc.
 - ◆ #5 PP Supersack Tote Bags
 - ◆ Drip Tape: Roll or Tie in Large Bundles
 - ◆ #4 LDPE Potting Soil Bags
- ◆ NO Plastic Mulch, Irrigation Headers or Hoses, NO Floating Row Covers, or Ground Covers.
- ◆ Pickup Service Available for Large Quantity
- ◆ We Appreciate a Call Before You Deliver

717-656-4422

Zook's Plastic Recovery

183 S. Farmersville Rd.
Leola PA 17540

1/2 mile north of Route 23
Between New Holland and
Leola; 1 Mile East of Leola
Auction & Nolt's Produce
zook.daniel1@gmail.com
www.zooksplastic.com





VENDORS BY NAME

A-1 Mist Sprayers

110 W. Third St., Ponca, NE 68770
877-924-2474, fax - 402-755-4134
www.mistsprayers.com

AgChoice Farm Credit *see ad on page 27*

900 Bent Creek Blvd., Mechanicsburg, PA 17050
888-998-5557
www.agchoicefarmcredit.com

Agri-Services Agency

1008 Applejack Dr., Gibsonia, PA 15044
800-256-4105, fax - 724-449-6336
www.AgServAgency.com

Arctic Refrigeration Co. *see ad on page 14*

26 Cedar St., Batavia, NY 14020
585-343-2678
www.arcticrefrigeration.com

Binkley & Hurst *see ad on page 5*

PO Box 0395, Lititz, PA 17543-0395
800-414-4705, fax - 717-626-0996
www.binkleyhurst.com

Blackmore Co. *see ad on page 18*

10800 Blackmore Ave, Belleville, MI 48111
800-874-8660, fax - 734-483-5454
www.blackmoreco.com

Black Rock Repair *see ad on page 12*

858 Pumping Station Rd., Kirkwood, PA 17536
717-529-6553

Buffalo Valley Produce Auction

Violet Road, Mifflinburg, PA 17844
570-966-1151 fax 570-966-2601
www.buffalovalleyproduce.com/

Countryside Produce Auction

1695 Savage Rd., Salisbury, PA 15558
814-662-2222

Crop Care/Paul B. LLC *see ad on page 7*

50 Woodcorner Rd., Lititz, PA 17543
717-738-7365 fax - 717-738-8061
www.cropcareequipment.com

Cumberland Valley Produce Auction

101 Springfield Rd., Shippensburg, PA 17257
717-530-5007

Daniel's Farm Store *see insert*

324 Glenbrook Rd., Leola, PA 17540
717-656-6982 fax - 717-656-8077

Danville Industries

124 West Main, Harper, KS 67058
800-662-4212 fax - 620-896-7192
www.danvillenodrift.com

A Safe, Sound, Strong Partner.



Today's financial markets may leave you with much uncertainty. However, you can be certain to trust Farm Credit as a safe, sound and strong partner in financing.

For more than 95 years we have served rural and agricultural communities across Pennsylvania. We continue to make loans for progressive, credit-worthy farmers, agribusinesses and other rural businesses and homeowners.

Call us today to learn about our sound lending practices and commitment to the agricultural industry. We're a partner you can trust.



800.998.5557
agchoice.com



FARM CREDIT
MIDATLANTIC

888.339.3334
mafc.com



VENDORS BY NAME

Dubois Agrinovation, Inc.

478 Notre Dame, St-Remi, Quebec, Canada J0L2L0
800-667-6279
www.duboisag.com

Gowan Company LLC

370 South Main Street, Yuma, AZ 85364
315-447-0560
www.gowanco.com

Gristmill Vegetable Farm *see ad on page 15*

201 Gristmill Rd, New Holland PA 17557
717-354-8444 fax - 717-354-8444

Haines Equipment

20 Carrington St., Avoca, NY 14809
607-566-2234 or 8531 fax - 607-566-2240
www.hainesequipment.com

Harris Moran Seed Co. *see ad on page 23*

555 Codoni Avenue, Modesto, CA 95357
209-579-7333 fax - 209-544-0335
www.harrismoran.com

Harris Seeds

PO Box 24966, Rochester, NY 14624-0966
800-544-7938
www.harriseseeds.com

Hillside Cultivator *see ad on page 6*

911 Disston View Dr., Littitz, PA 17543
717-626-6194
www.hillsidecultivator.com

Hoover Tractor Co.

11715 Old Turnpike Rd., Mifflinburg, PA 17844
570-966-3821 fax - 570-966-5096
www.hoovertractor.net/

I & J Manufacturing *see ad on page 6*

5302 Amish Rd., Gap, PA 17527
717-442-9451
www.farmingwithhorses.com

International Paper *see ad on page 24*

342 E. York St., Biglerville, PA 17307
800-222-8984, fax - 717-677-9455
www.internationalpaper.com/US/EN/Business/IPG.htm

IPM Laboratories

PO Box 300, Locke, NY 13092-0300
315-497-2063, fax - 315-497-3129
www.ipmlabs.com

Iva Manufacturing

175 Churchtown Rd., Narvon, PA 17555
717-768-0747 fax - 717-768-8350

Johnny's Selected Seeds

PO Box 299, Waterville, ME 04903
877-546-6697
www.johnnyseeds.com

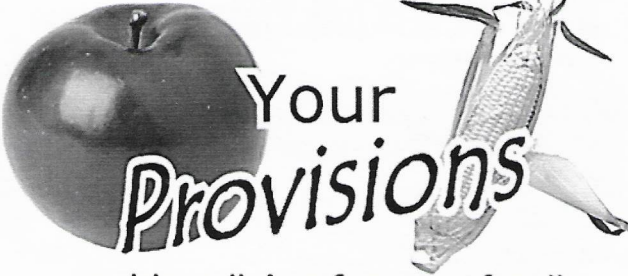

Your Provisions

provide a living for your family and their basic needs.

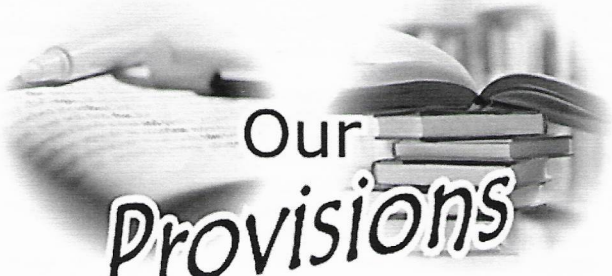

Our Provisions

provide a product to protect YOUR livelihood; enabling you to continue to provide for your loved ones.

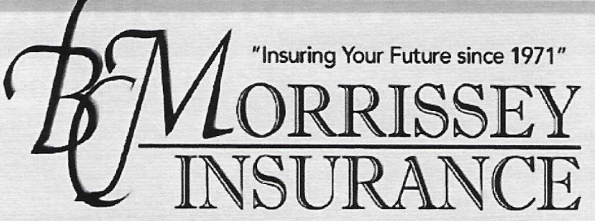

Choose an agency that works for you, providing competitive prices and superior service!

**Crop • Farm • Auto • Home
WorkComp • Business • Life**

**890 North Reading Rd. • Ephrata, PA 17522
13025 Route 6 • Troy, PA 16947**

www.insuringyourfuture.com

800-422-8335

 Find us on Facebook

New Farm Bill. Better risk management tools.
But you still can't control Mother Nature.

Is your risk management plan good enough?

1. Figure out the safety net you need.

- What do you plan to grow?
- What are your input costs?
- What's your expected revenue?

2. Seek farm bill options and advice:

- crop insurance agents,
- your county FSA office,
- NRCS representatives,
- Penn State Extension.

3. Choose the best options.

Because this time, it's your responsibility to develop a plan that protects against the next disaster.



This institution is an equal opportunity provider.

Find a crop insurance agent at
www3.rma.usda.gov/apps/agents.



pennsylvania
DEPARTMENT OF AGRICULTURE

717.705.9511 | cropinsurancepa.com

Tom Corbett, Governor

George Greig, Agriculture Secretary

VENDORS BY NAME

Jordan Seeds, Inc. *see ad on page 24*

6400 Upper Afton Rd., Woodbury, MN 55125
651-738-3422, fax - 651-731-7690
www.jordanseeds.com

JWB Marketing

2308 Raven Tr., West Columbia, SC 29169
800-555-9634
www.birdcontrolsupplies.com

Keen Green LLC

5641 Crescent Beach Loop, Dover, FL 33527
717-389-5992
www.KeenGreenGarden.com

Kirkwood Produce Auction

1597 Kirkwood Rd., Kirkwood, PA 17536
717-529-2748

KoolJet Refrigeration, Inc. *see ad on page 14*

9 Myrtle St., Tillsonburg, ON Canada N4G 4G4
866-748-7786 fax - 866-748-7760
www.kooljet.com

Krohne Plant Farm *see ad on page 19*

65295 CR 342, Hartford, MI 49057
269-424-5423 269-424-3126
www.krohneplantfarms.com

Kutztown Produce Auction

209 Oakhaven Rd., Fleetwood, PA 19522
610-683-7161 fax 610-683-5429
http://theplantauction.com/

Lebanon Produce Auction

2862 Harvest Rd., Elizabethtown, PA 17022
717-367-8379

Leola Produce Auction

PO Box 307, Leola, PA 17540
717-656-9592

Maplewood Produce Greenhouse

8564 Old Scotland Rd., Shippensburg, PA 17257
717-532-3278

Market Farm Implement *see ad on page 4*

257 Fawn Hollow Rd., Friedens, PA 15541
814-443-1931
www.MarketFarm.com

Martin's Produce Supplies *see ad on page 18*

627 Britton Rd., Shippensburg, PA 17257
888-381-8641 fax - 717-532-5872

Martin's Repair Shop *see ad on page 10*

28 E. Trout Run Rd., Ephrata, PA 17522
717-733-3015, fax - 717-733-9618

Marvel Plastic Mulch-Irrigation, Robert *see ad on page 13*

2425 Horseshoe Pike, Annville, PA 17003
800-478-2214, fax - 717-838-0978
www.RobertMarvel.com

Mechanical Transplanter Co. *see ad on page 4*

1150 Central Ave., Holland, MI 49423-5230
800-757-5268, fax - 616-396-3619
www.mechanicaltransplanter.com

Messick Farm Equipment *see ad on page 11*

187 Mertz Dr, Elizabethtown 17822
800-222-3373
www.messicks.com

MidAtlantic Farm Credit *see ad on page 27*

45 Aileron Ct, Westminster, MD 21157
888.339.3334
www.maafc.com

Morrison's Cove Produce Auction

174 Windy Acres Ln., Roaring Springs, PA 16673
814-793-9384

Morrissey Insurance Inc., Bernard *see ad on page 28*

890 N. Reading Rd., Ephrata, PA 17522
800-422-8335, fax - 717-336-3729
www.insuringyourfuture.com

Nolt's Produce Supplies *see ads on pages 8 & 23*

152 North Hershey Ave., Leola, PA 17540
717-656-9764

Nourse Farms, Inc. *see ad on page 19*

41 River Rd, South Deerfield, MA 01373
413-665-2658, fax - 413-665-7888
www.noursefarms.com

Nutri-Cal / CSI Chemical Corp. *see ad on page 19*

10980 Hubbell Ave., Bondurant, IA 50035
800-247-2480
www.nutri-cal.com

Oregon Ag

1150 E. Oregon Rd, Lititz, PA 17543
717-656-0067, 717-284-7106

Oxford Produce Auction

200 Union School Rd., Oxford, PA 19363
610-392-2722



*Truckload of tomatoes crossing the Susquehanna River heading to Furmano's in Northumberland.
Photo by John Shenk.*

VENDORS BY NAME

Penns Creek Welding & Manufacturing *see ad on page 10*
 1340 Broadway Road, Winfield, PA 17889
 570-837-1197
 www.pennscreekwelding.com

Penna. Department of Agriculture *see ad on page 29 & insert*
 2301 N Cameron St., Harrisburg, PA 17110-9408
 717-705-9511
 www.pda.state.pa.us

Perdue AgriRecycle *see ad on page 16*
 28338 Enviro Way, Seaford DE 19973
 302-628-2361 fax 302-628-7943
 www.perdueagrirecycle.com

PA Preferred Program *see ad on page 31*
 2301 N Cameron St., Harrisburg, PA 17110-9408
 717-772-3094
 www.papreferred.com

Penna. Ass'n. for Sustainable Ag.
 PO Box 419, Millheim, PA 16854
 814-349-9856, fax - 814-349-9840
 www.psafarming.org

Penna. Vegetable Marketing and Research Program
 2301 N. Cameron St., Harrisburg, PA 17110
 717-694-3596
 www.paveggies.org

Pirring Auctioneers, Inc. *see ad on page 26*
 PO Box 607; 2731 East Naple Street; Wayland, NY 14572
 585-728-2520, fax - 585-728-3378
 www.pirringinc.com

Plant Food Company
 38 Highstown-Cranbury Station Rd., Cranbury, NJ 08512
 800-562-1291
 www.plantfoodco.com

ProducePackaging.com *see our ad on page 15*
 PO Box 609; 20 Market St., Bangor, PA 18013
 800-644-8729
 www.producepackaging.com

Putnam Plastics, Farm Products Div. *see ad on page 17*
 255 S. Alex Rd., West Carrollton, OH 45449
 800-457-3099, fax - 937-866-9365
 www.putnamplastics.com

Rain-Flo Irrigation *see ad on page 9*
 929 Reading Rd., East Earl, PA 17519
 717-445-3000, fax - 717-445-8304
 www.rainfloirrigation.com

Reed's Seeds *see ad on page 20*
 3334 NYS Rte. 215, Cortland, NY 13045
 607-753-9095, fax - 607-753-9511

Rimol Greenhouse Systems *see ad on page 18*
 40 London Derry Tpk., Hooksett, NH 03106
 603-494-5775, fax - 603-629-9023
 www.rimol.com

Rockford Packaging *see ad on page 17*
 10421 Northland Dr., Rockford, MI 49341
 800-444-PACK
 www.rockfordpack.com

BUY PENNSYLVANIA GROWN FRUITS & VEGETABLES

[pinterest.com /papreferred](http://pinterest.com/papreferred)
[facebook.com /PAPreferred](https://www.facebook.com/PAPreferred)

VENDORS BY NAME

Rupp's Seeds *see ad on page 25*

17919 Road B, Wauseon, OH 43567
419-337-1841, fax - 419-337-5491
www.ruppseeds.com

Saylor's Farm Products *see ad on page 17*

17319 Rt 68, Sligo, PA 16255
814-745-2306
www.saylorsfarm.com

SeedWay *see ad on page 20*

1225 Zeager Rd., Elizabethtown, PA 17022
800-952-7333, fax - 717-367-0387
www.seedway.com

Seminole Produce Distributing Inc.

PO Box 4521, Sanford, FL 32772
407-322-7785 or 717-525-8372
www.freshveggie.com

Shippensburg Produce Auction

1120 Ritner Hwy., Shippensburg, PA 17257
800-346-2334

Siegers Seed Co. *see ad on page 22*

13031 Reflections Dr, Holland, MI 49464
800-962-4999, 616-786-4999, fax - 616-994-0333
www.siegers.com

Smicksburg Produce Auction

1526 Barnard Rd., Smicksburg, PA 16256

Snyder County Produce Auction

6130 S. Susquehanna Trail, Port Trevorton, PA 17864
570-374-0284 fax 570-374-0693
www.snydercountyproduce.com

Stand'N Plant *see ad on page 6*

95 Rose Rd., Saltsburg, PA 15681
724-639-3965 or 724-349-5167
www.standnplant.com

Stauffer Engine and Equipment, Wes *see ad on page 8*

23 Pleasant Valley Rd., Ephrata, PA 17522
717-738-4215
www.wesstauffer.com

Stokes Seeds *see ad on page 21*

Box 548, Buffalo, NY 14240
800-263-7233, fax - 888-834-3334
www.stokeseeds.com

Sugar Valley Produce Auction

Loganville, PA
570-725-2000

Sunnyburn Produce Auction

101 Atkins Rd., Airville, PA 17302
717-862-3010

Swihart Sales Co. *see ad on page 12*

7240 County Rd AA, Quinter, KS 67752
800-864-4695/785-754-3513, fax - 785-754-3634
www.swihart-sales.com

Tew Manufacturing Corp. *see ad on page 17*

PO Box 87; 470 Whitney Rd.; Penfield, NY 14526
800-380-5839, fax 585-586-6083

Timac Agro USA *see insert*

PO Box 888, Reading, PA 19607-0888
800-545-5474
www.timacusa.com

Toro Micro-Irrigation *see ad on page 13*

1588 N. Marshall Ave., El Cajon, CA 92020
757-710-0320
www.toromicroirrigation.com

Trickl-Eez Co.

3550 Chambersburg Rd., Biglerville, PA 17307
800-672-4700 fax - 717-337-1785
www.trickl-ezz.com

Tri-County Produce Auction

3238 State Route 208
New Wilmington, PA 16142
724-946-8540

Tunnel Tech

694 Kraybill Church Rd, Mount Joy, PA
855-888-8663
www.tunneltech.ca

Twilley Seeds *see ad on page 22*

121 Gary Rd., Hodges, SC 29653
800-622-7333 fax - 864-227-5108

USA Gypsum

1802 Texter Mountain Rd., Reinholds, PA 17569
717-335-0379 fax - 717-335-2561
www.usagypsum.com

Weaverland Produce Auction

485 Quarry Rd., New Holland, PA 17557
717-355-0834

Woodhouse Co., J. S. *see ads on pages 10, 14 and 26*

572 Industrial Dr. Lewisberry PA 17339
717-938-5100 fax - 413-732-3786
www.jswoodhouse.com

Zook's Plastic Recovery *see ad on page 27*

183 S. Farmersville Rd Leola PA 17540
717-656-4422 fax - 717-656-9615
www.zooksplastic.com

PA
*Preferred*TM
 Grown in PA. It makes a difference.

Winter squash display at Miller Plant Farm in York.



Steve Bogash explaining his trials at the 2013 Vegetable Field Day at the Southeast Pennsylvania Research and Extension Center in Manheim.

Tomato variety taste testing at 2013 Vegetable Field Day at the Southeast Pennsylvania Research and Extension Center in Manheim.

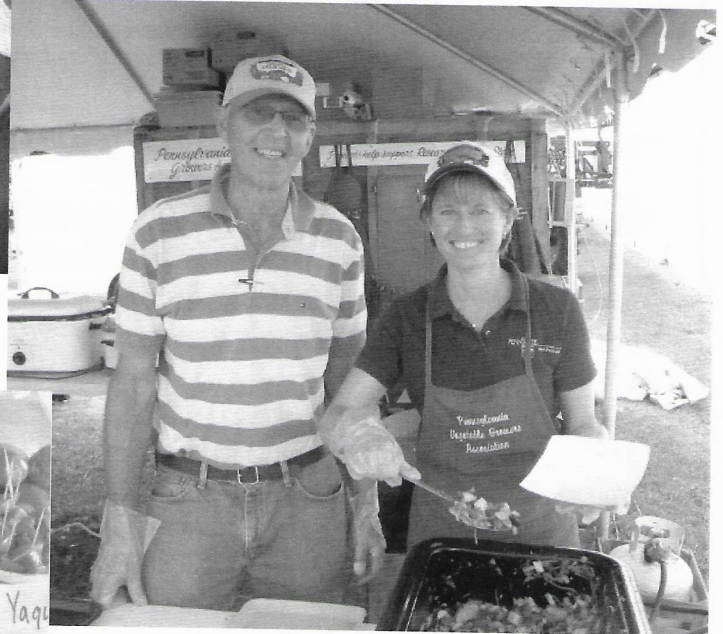

Mike Orzolek and Beth Gugino serving vegetable stir-fry at the PVGA booth at Ag Progress Days in Rock Springs.



GENERAL

PVGA Membership and Mid-Atlantic Fruit & Vegetable Convention Registration Form

Name _____
 Farm Name _____
 Address _____
 City/State _____ Zip Code _____
 PA County _____ Telephone ____/____/____ Cell Phone ____/____/____
 Facsimile ____/____/____ Electronic Mail _____

Business Information Please check all that apply.
 Grower (owner-operator) Retail Wholesale
 Fresh Market Vegetables Processing Vegetables Greenhouse Vegetables Potatoes
 Small Fruit Bedding Plants Cut Flowers Tree Fruit/Wine Grapes
 Grower Employee
 Supplier (equipment, chemicals, etc.) Processor Other _____

2015 PVGA Membership Dues

Regular Membership Dues increase to \$55 after January 29. \$50.00 _____
 Open to all owner, operators and employees of vegetable, potato and berry farm operations, processing firms and supply companies. Includes newsletter subscription.
Associate Regular Membership Includes newsletter subscription. \$30.00 _____
 Must be one of the following - circle one: Student Retired University Staff Extension Agt.
Keystone Membership An optional membership category open to vegetable and berry farming operations, processing firms, and supplier firms. Includes newsletter subscription.
 Dues based on gross income from vegetable potato or berry industries. Any member paying \$75 or more in dues will be considered a Keystone Member. The following rates are only suggestions.
 \$75 for up to \$75,000 \$100 for \$75,000 to \$150,000 \$150 for \$150,000 to \$225,000
 \$200 for \$225,000 to \$500,000 \$275 for \$500,000 to \$1,000,000 \$375 for over \$1,000,000
Associate Keystone Membership Must be a family member or employee of a Keystone Member. \$30.00 _____
 Includes newsletter subscription.

2015 Mid-Atlantic Fruit and Vegetable Convention

REGISTRATION IS REQUIRED FOR EACH PERSON, including spouses. Registration fees allow one to attend both fruit and vegetable sessions as well as enter the exhibit area. Each registrant also receives a copy of the Proceedings. Students and children 16 and under receive free registration. No refunds of pre-registration fees will be made unless canceled by January 23 in writing, by phone (717-694-3596) or by email (pvga@pvga.org). No confirmation will be mailed prior to the Convention.

PLEASE LIST THE NAME OF EACH PERSON ATTENDING (for use in preparing nametags)

Member Registration *one fee whether you are attending for 1, 2 or 3 days - per person*
 Advance for the first person from a family, farm or business (\$80 after Jan. 16) ____ @ \$65.00 _____
 Advance for additional persons from a family, farm or business (\$80 after Jan 16) ____ @ \$60.00 _____
Non - Member Registration - (family and employees of PVGA members will be admitted at the above member's rates.)
 One Day *per person* ____ @ \$110.00 _____
 Three Day *includes registration for 2 or 3 days per person.* ____ @ \$150.00 _____
Student /Children Registration *for students and children 16 and under only* ____ @ no charge
Workshops/Tour **PRE-REGISTRATION IS REQUIRED FOR THESE EVENTS** *please indicate who will be attending below*
 Irrigation Water Toolbox – Jan. 26 (with lunch) names _____ @ \$50.00 _____
 PA Pesticide App Training – Jan. 26 (with lunch) names _____ @ \$50.00 _____
 New Organic Veg Prod. School – Jan. 26 (with lunch) names _____ @ \$100.00 _____
 FSMA Farm Food Safety – Jan. 26 (with lunch) names _____ @ \$50.00 _____
 USDA-AMS Grant Writing – Jan. 26 (with lunch) names _____ @ \$20.00 _____
 Ag Literacy – Jan. 26 (no lunch) names _____ @ \$50.00 _____
 Farm Market Bus Tour – Jan. 26 names _____ @ \$60.00 _____

Meals Annual Growers Dinner – January 27 ____ @ \$35.00 _____

Proceedings Registration includes a **free copy** (\$15 if picked up at the Convention) ____ @ \$20.00 _____

Country Folks Grower -Check here to receive a free monthly subscription to this publication ____

Total Enclosed Payment by check or money order only - make checks payable to "PVGA" _____

Mail this registration form and payment to **(Credit/debit card payments cannot be processed):**

Pennsylvania Vegetable Growers Association, 815 Middle Road, Richfield, PA 17086-9205 717-694-3596 - phone and fax

IMPORTANT TELEPHONE NUMBERS

Poison Control Center 800-222-1222
Agri-Service Agency – health and worker's compensation
 insurance for PVGA members 800-256-4105

Integrated Pest Management Hotline & Pesticide Update Credit Information 800-PENN-IPM

Penn State Cooperative Extension Offices

Adams	717-334-6271
Allegheny	412-473-2540
Armstrong	724-548-3447
Beaver	724-774-3003
Bedford	814-623-4800
Berks	610-378-1327
Blair	814-940-5989
Bradford	570-265-2896
Bucks	215-345-3283
Butler	724-287-4761
Cambria	814-472-7986
Cameron	814-486-3350
Carbon	570-325-2788
Centre	814-355-4897
Chester	610-696-3500
Clarion	814-223-9028
Clearfield	814-765-7878
Clinton	570-726-0022
Columbia	570-784-6660
Crawford	814-333-7460
Cumberland	717-240-6500
Dauphin	717-921-8803
Delaware	610-690-2655
Elk	814-776-5331
Erie	814-825-0900
Fayette	724-438-0111
Forest	814-755-3544
Franklin	717-263-9226
Fulton	717-485-4111
Greene	724-627-3745
Huntingdon	814-643-1660
Indiana	724-465-3880
Jefferson	814-849-7361
Juniata	717-436-7744
Lackawanna	570-963-6842
Lancaster	717-394-6851
Lawrence	724-654-8370
Lebanon	717-270-4391
Lehigh	610-391-9840
Luzerne	570-825-1701
Lycoming	570-433-3040
McKean	814-887-5613
Mercer	724-662-3141
Mifflin	717-248-9618
Monroe	570-421-6430
Montgomery	610-489-4315
Montour	570-784-6660
Northampton	610-746-1970
Northumberland	570-988-3950
Perry	717-582-5150
Philadelphia	215-471-2200
Pike	570-296-3400
Potter	814-274-8540
Snyder	570-784-6660
Schuylkill	570-622-4225
Somerset	814-445-8911
Sullivan	570-928-8941

Penn State Cooperative Extension Offices (continued)

Susquehanna	570-278-1158
Tioga	570-724-9120
Union	570-966-8194
Venango	814-437-7607
Warren	814-563-9388
Washington	724-228-6881
Wayne (extension 239)	570-253-5970
Westmoreland	724-837-1402
Wyoming	570-836-3196
York	717-840-7408

Pennsylvania Department of Agriculture
 Pesticide Regulations, Worker Protection Standards,
 Chemsweep Program, Plant Inspection, Food Safety
 Inspection - contact nearest regional office

Northwest - Meadville	814-332-6890
North Central - Montoursville	570-433-2640
Northeast- Tunkhannock	570-836-2181
Southwest - Gibsonia	724-443-1585
Southwest Central - Altoona	814-946-7315
Southeast Central - Harrisburg	717-346-3229
Southeast - Creamery	610-489-1003
Seasonal Farm Labor	717-787-4315
Market Development	717-783-8462
Produce Promotion Program	717-787-6901
Food Safety	717-787-4315
Plant Industry - Pesticides	717-787-4843
Fruit and Vegetable Inspection ext 220	717-787-5107
Farmers' Market Nutrition Program	717-772-2693

Pennsylvania Department of Labor & Industry

General Information	717-787-5279
Workers' Compensation	800-482-2383
Right to Know	717-783-1826

Pennsylvania Dept. of Environmental Protection
 Storage Tanks 800-42TANKS

Pennsylvania Vegetable Marketing & Research
 Program 717-694-3596

Produce Market News

Philadelphia	215-551-6791
Pittsburgh	412-644-5847

United States Department of Labor

Wage & Hour Division – Philadelphia	215-597-4950
Wage & Hour Division – Wilkes-Barre	570-826-6316
Wage & Hour Division – Pittsburgh	412-395-4996
OSHA – Philadelphia	215-597-4955
OSHA – Wilkes-Barre	570-826-6538
OSHA – Harrisburg	717-782-3905
OSHA – Pittsburgh	412-395-4903

**If you do not know who to call, call the
 Pennsylvania Vegetable Growers Association
 at 717-694-3596**

We can help find an answer.

Pennsylvania Vegetable Growers Association
815 Middle Road
Richfield, Pennsylvania 17086-9205
717-694-3596
pvga@pvga.org
www.pvga.org

PRESORTED
STANDARD
U.S. POSTAGE
PAID
MIDDLEBURG PA 17842
PERMIT NO. 26

Change Service Requested

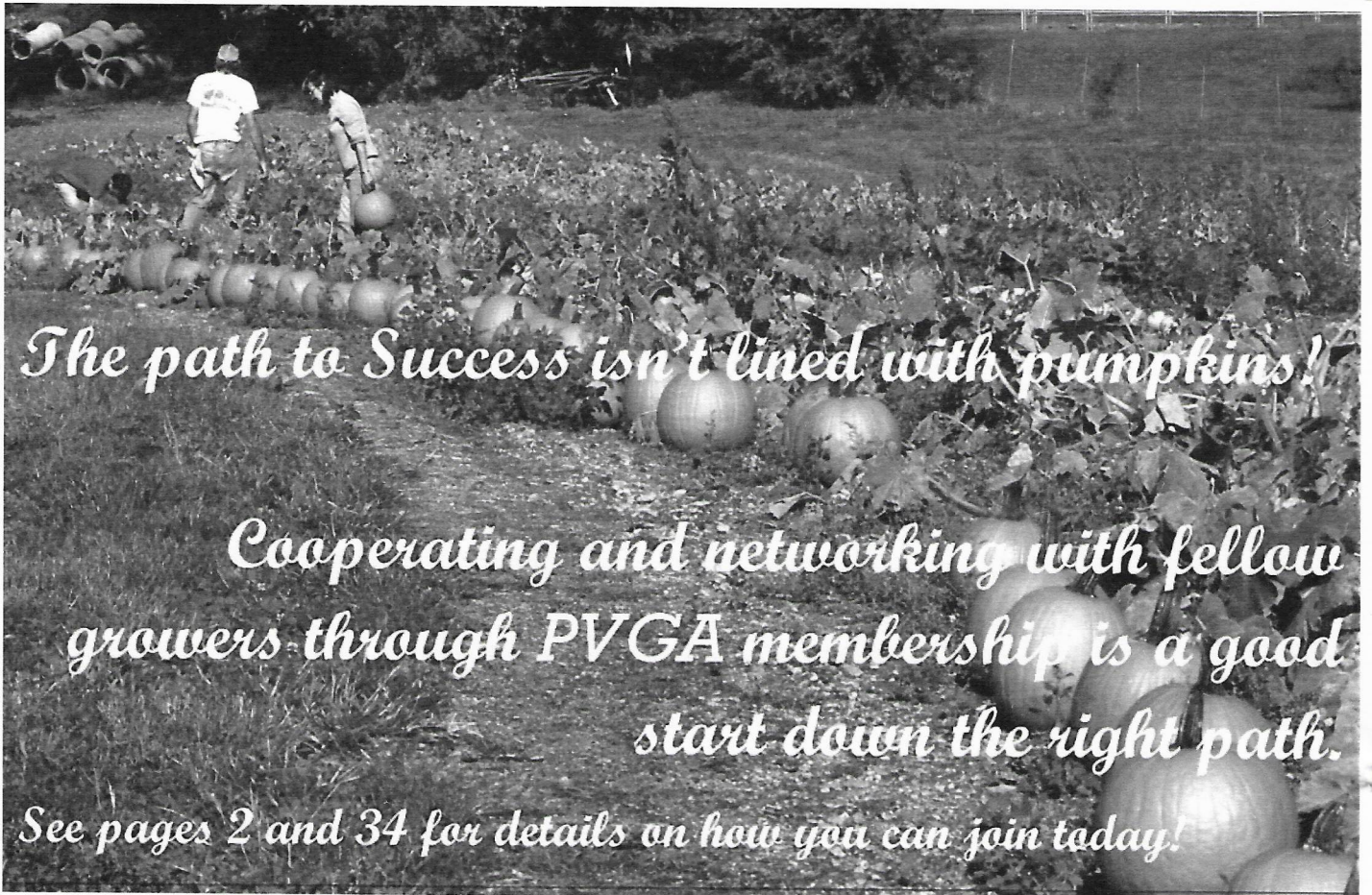

The path to Success isn't lined with pumpkins!

Cooperating and networking with fellow growers through PVGA membership is a good start down the right path.

See pages 2 and 34 for details on how you can join today!

Penn State **Extension**

New USDA Crop Insurance Covers Whole Farm

Whole Farm Revenue Protection is a new crop insurance policy called for in the 2014 Farm Bill and developed by the USDA's Risk Management Agency.

This newly available crop insurance product is not intended for a single specific crop, but for all the crops, livestock and products that are grown, raised or produced on a farm.

This new insurance may be of special interest to diversified, specialty crop and organic farmers who do not have single crop policies or organic price elections available.

Producers should start talking with their crop insurance agents if they are interested in applying for a WFRP policy by the March 16 sales closing date.

Some of the most notable benefits this new insurance option offers include:

- An \$8.5 million liability limit – an increase from \$6.5 million under Adjusted Gross Revenue insurance and \$1 million under AGR-Lite.
- 85 percent of historical revenue coverage level when at least three crops are grown - an increase over the previous 80 percent cap.
- A premium subsidy of up to 80 percent when at least two crops are grown - a significant increase over the highest subsidy rate of 59 percent provided under AGR-Lite.
- A premium discount for increased diversification stair-stepped up to seven crops.
- Coverage for both crops and livestock, capped at 35 percent of expected revenue up to \$1 million.
- Inclusion of some incidental processing expenses necessary to make the commodity ready for market, such as washing, trimming and packaging.
- Replant coverage for crop losses early enough for replanting.
- The continued option to insure individual crops under separate crop policies (cannot be catastrophic, or CAT, level coverage).

The fact sheet on this new tool is available at
<http://www.rma.usda.gov/policies/2015/wfrpfactsheet.pdf>.

Find a list of certified crop insurance sales agents at
<http://www.rma.usda.gov/tools/agent.html>.

Source: John Berry, Penn State Extension (Reprinted with permission)

Crop Insurance Improvements Authorized by the Farm Bill

- 1. More coverage options – Many are listed below**
- 2. Improved NAP Protection** (Non-insured crop disaster Assistance Program from FSA) provides up to 65 percent level of coverage and 100 percent of projected price for most non-insurable crops
- 3. New Irrigated/Non-Irrigated Acreage Options** - Separate enterprise insurance units and different coverage levels are allowed
- 4. Improved Organic Protection**
 - a. Organic elections availability for more crops
 - b. Extended for organic price coverage – for 2014, to eight additional crops (oats, peppermint, apricots, apples, blueberries, almonds, pears, and grapes for juice) to a total of sixteen (producer has the option of using organic or conventional prices)
 - c. Five percent premium surcharge is removed for organic price options
- 5. New benefits for being beginning farmers**
 - a. Additional 10 percentage points of premium subsidy for additional coverage policies (buy-up) that have premium subsidy;
 - b. Exemption from paying the administrative fee for catastrophic (CAT) and additional coverage (buy up) level policies;
 - c. Use of the production history of farming operations, if BFs were previously involved in the decision making or physical activities; and
 - d. An increase in the substituted yield for yield adjustment, which allows a replacement of a low yield due to an insured cause of loss, from 60 to 80 percent of the applicable transitional yield (T-Yield) for the crop in the county.
- 6. New T-Yield Options** (effective beginning with 2015 crop year Spring Crops) - When a crop in a county suffers over a 50 percent yield loss, producers in that county and adjacent counties may omit their yield for that year's production. For this provision, the Federal Crop Insurance Corporation may make a separate determination for irrigated and non-irrigated acreage. Note: The current 60% yield plug is retained for replacing low APH yields (80% yield plug for new and beginning farmers).
- 7. New improved Whole-Farm Revenue Protection** (\$8.5 mil. max. revenue)
 - a. Covers all farm commodities including animal and animal products revenue including commodities purchased for resale (limit up to 50% of total expected revenue) (no protection for timber forest, forest products and animals for sport, show or pets)
 - b. Coverage levels from 50 to 85% of expected revenue (covers min. market readiness costs)
 - c. Covers natural causes of loss and declining market prices within the insurance year
 - d. Premium subsidies vary from 55% to 80%.
 - e. Opportunity to also purchase MPC I Buy-Up policies for selected individual crops
- 8. Supplemental Coverage Option (SCO)** – An option to buy area/county loss trigger insurance to cover yield or revenue loss (depending on the coverage in effect of the individual policy). The level of coverage is between 86% and coverage of individual policy. Premium is subsidized at 65% subsidy. SCO covers all planted acres with no payment limitation (not available for crops covered by ARC.) SCO coverage for 2015 available (2016 info. expected about 11/17/16) at:
<http://www.rma.usda.gov/news/currentissues/farmbill/2015scomap.pdf>
- 9. Conservation Compliance Certification** – By June 1, 2015, farmers must file form AD-1026 with the Farm Service Agency (FSA) to be eligible for premium subsidy on crop insurance policies in the 2016 Reinsurance year (July 1, 2015 to June 30, 2016). Farmers and any affiliated persons must be in compliance with the HELC and WC provisions.

Contact: Risk Management Specialist Jordan Stasyszyn, 717-705-9511, jstasyszyn@pa.gov

YOUR BIOSTIMULANT FERTILIZER SOLUTIONS FROM TOP TO BOTTOM

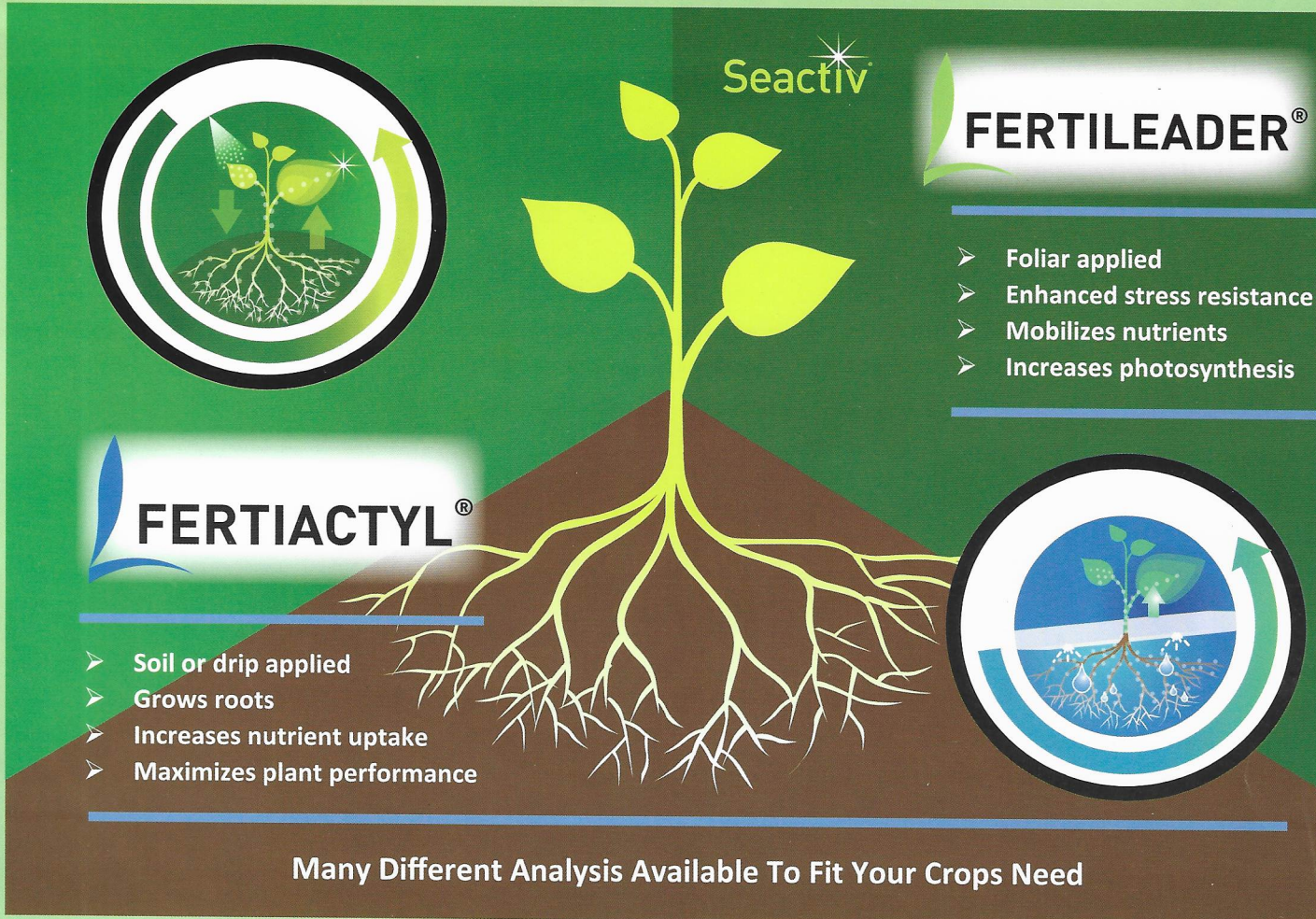

Seactiv

FERTILEADER®

- Foliar applied
- Enhanced stress resistance
- Mobilizes nutrients
- Increases photosynthesis

FERTIACTYL®

- Soil or drip applied
- Grows roots
- Increases nutrient uptake
- Maximizes plant performance

Many Different Analysis Available To Fit Your Crops Need

Daniel's Farm Store

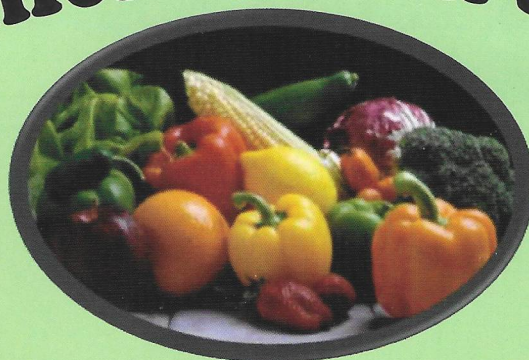

SUPPLIER OF VEGETABLE FERTILIZER AND CROP PROTECTION PRODUCTS

Timac Agro Fertilizers, KSC Water Soluble, Fertileader Foliars, Fertiactyl Starters and Granular Fertilizers.
Agricultural Chemicals, Biological Pesticides and Beneficial Insects

324 Glenbrook Rd. Leola PA 17540

717 656 6982

EARLY ORDER AND QUANTITY DISCOUNTS AVAILABLE



HIGH TECH WATER SOLUBLE FERTILIZERS

From A World Leader In Plant Nutrition

**WATER SOLUBLE FERTILIZERS
WITH PHYT-ACTYL**



**HIGHLY AVAILABLE NUTRIENTS, SOLUBLE, LOW SALT,
NO UREA**

PHYT-ACTYL RESULTS

**1. INCREASED ROOT
ACTIVITY AND
ABSORPTION**



**2. INCREASED FLOWER
AND FRUIT**

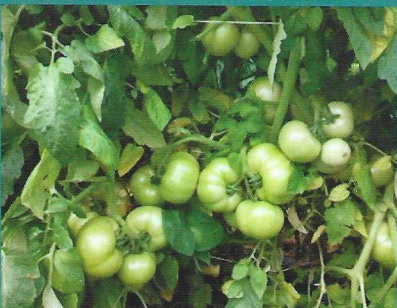

**3. INCREASED
METABOLITE
MOVEMENT FOR
BETTER SIZE AND
FLAVOR**



- BUFFERED TO MAINTAIN AVAILABILITY AND SOLUBILITY UNDER HIGH PH, HIGH ALKALINE IRRIGATION WATER
- CONTAINS THE PHYTACTYL COMPLEX FOR MAXIMUM CROP RESPONSE

Analysis Available:

- KSC I:** 14-40-5 with S and Micros
- KSC IV:** 0-32-40 with Micros
- KSC V:** 8-16-42 with Micros
- KSC VI:** 14-12-14 with S and Micros
- KSC VII:** 15-0-9 with 20% calcium oxide
- KSC MIX:** High Mag and Micros



Better Yield, Size, Quality, And Flavor

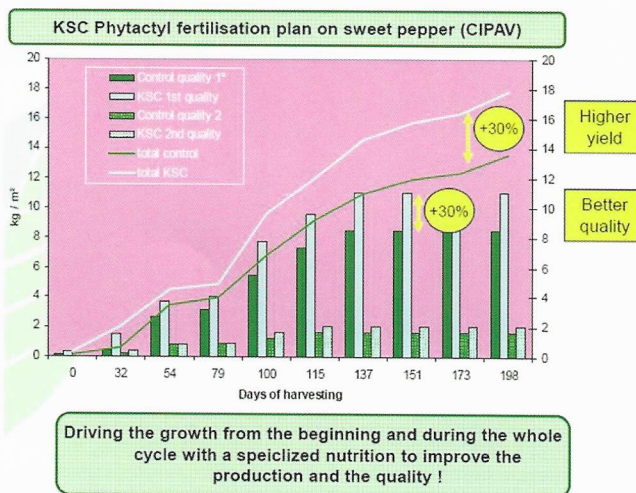

**Contact Daniels Farm Store 717 656 6982 To Order
Early Order and Quantity Discounts Available**