

PENNSYLVANIA
VEGETABLE GROWERS

NEWS

January 2022 / Volume 45 Number 1

for the commercial vegetable, potato and berry grower



2022 Buyers' Guide



GENERAL



*Pennsylvania
Vegetable Growers
Association*

*An association of
commercial vegetable,
potato and berry growers.*

President

Rita Resick '23
Somerset

First Vice President

Peter Flynn '24
West Chester

Second Vice President

Tina Forry '25
Palmyra

Secretary-Treasurer

William Reynolds '25
Waynesboro

Past President

Brian Campbell '24
Berwick

Directors

Christopher Harner '23
State College

Barron Hetherington '25
Ringtown

Alan Kemmerer '25
Berwick

Arthur King '24
Valencia

Amy Metrick '24
Butler

Michael Orzolek '24
State College

Christopher Powell '23
Strasburg

John Shenk '23
Lititz

Robert Shenot '25
Wexford

Jeffrey Stoltzfus '23
Atglen

Jonathan Strite '25
Harrisburg

Mark Troyer '24
Waterford

Joel Weaver '23
Windber

Executive Director

William Troxell
Richfield

Dear Pennsylvania Grower

This special edition of the Pennsylvania Vegetable Growers News, the monthly newsletter of the Pennsylvania Vegetable Growers Association, has been prepared as a source book of information for you, the Pennsylvania grower. We have listed various vendors of equipment, supplies and services who deal with Pennsylvania growers. Keep this booklet handy to refer to throughout the year.

We also ask you to consider joining the Pennsylvania Vegetable Growers Association. If you are a vegetable, potato or berry grower, you should belong to the organization that represents your industry. Founded in 1926, PVGA has been serving growers like you for the past 95 years. Your membership will strengthen the Association's position as the official voice of the vegetable, potato and berry industries and will also provide numerous benefits to you.

For example, each year the Association co-sponsors the Mid-Atlantic Fruit and Vegetable Convention in Hershey. This year's Mid-Atlantic Convention was held in-person February 1 to 3 and was designed to continue the tradition of providing several days of concurrent educational sessions on processing vegetables, fresh market vegetables, potatoes, small fruits, direct marketing, and organic vegetables. The Mid-Atlantic Convention has become one of the premier grower meetings in the northeast and beyond. As a member of the Association, you help make this convention possible. PVGA normally also sponsors regional grower meetings and farm market tours and hopes these grower events can resume in 2022 as in-person meetings return to normal.

As a member, you will receive monthly subscriptions to this newsletter, the **Pennsylvania Vegetable Grower News**, to keep you informed on what is happening in the vegetable, potato and berry industries. PVGA members also receive free subscriptions to the **American Vegetable Grower** and the **Vegetable Growers News**.

The Association typically contributes over \$70 per member to vegetable and small fruit research. Over the past 33 years, PVGA has given over \$1.3 million to research. This has been made possible from profits of the Association's food booth at the Pennsylvania Farm Show and from Convention profits. The food booth also helps to promote the vegetable and berry products you produce.

PVGA represents the interests of the vegetable, potato and berry industries on both state and federal issues. The Association contacts legislators regularly on issues that affect our growers. Special attention is given to food safety, state budget appropriations, labor, deer crop damage, irrigation (water use), high tunnels, and pesticides as they relate to horticultural growers.

The Association is also a member of the State Council of Farm Organizations, the International Fresh Produce Association and the Penn State Agricultural Council, again with the purpose of representing the vegetable, potato and berry industries in the public arena and to Penn State University researchers and administrators.

The bottom line is this. A \$70 membership in the Pennsylvania Vegetable Growers Association is worth every penny. For each member, about \$70 is given to research and about \$30 is spent to publish the **Pennsylvania Vegetable Growers News**. Members also receive subscriptions to the **American Vegetable Grower** magazine and the **Vegetable Growers News**.

If you are not currently a PVGA member, we urge you to support the Association that represents your livelihood by joining today. Join your fellow growers in working together to benefit the entire grower community in providing educational events and resources, funding practical research, advocating for our industry and promoting our products.

Use the form on page 30 of this newsletter to join today!

*The **Pennsylvania Vegetable Growers News** is the official monthly publication of the
Pennsylvania Vegetable Growers Association, Inc.,
815 Middle Road, Richfield, PA 17086-9205*

Phone and fax: 717-694-3596 • Email: pvga@pvga.org • Website: www.pvga.org

Our Mission:

The Pennsylvania Vegetable Growers Association serves Pennsylvania's commercial vegetable, potato and berry growers through education, research, advocacy and promotion.

Our Vision:

The Pennsylvania Vegetable Growers Association will be the driving force in ensuring the future viability of the commercial vegetable, potato and berry industries in Pennsylvania.

Inquiries about membership, this publication or advertising rates should be directed to William Troxell, Executive Director, at the above address.

GENERAL

*Growers Working Together to Benefit Growers
is the reason PVGA exists.*

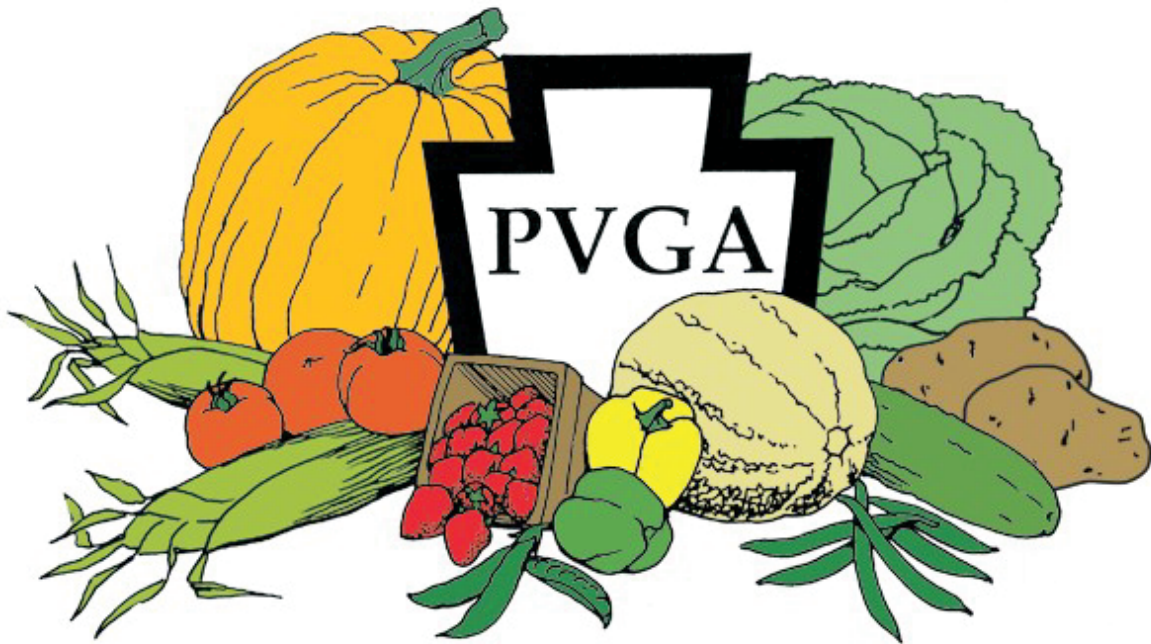

*Serving Growers for 95 Years
1926 - 2021*

Publishing the Pennsylvania Vegetable Growers News monthly newsletter
and PVGA Update weekly email update.

Sponsoring the Mid-Atlantic Fruit and Vegetable Convention
and local grower meetings.

Funding \$1.3 million in vegetable and small fruit research since 1989.

Representing the interests of Pennsylvania growers and
Promoting their products.

PVGA – Growers Working Together to Benefit Growers

VENDORS BY CATEGORY

Vendors are listed below by category of the equipment, supplies or services they offer. An alphabetical listing of vendors and their addresses begins on page 25.

General Equipment

Tillage and Cultivating Equipment

Hillside Cultivator – 717-626-6194
 I & J Manufacturing – 717-442-9451
 Market Farm Implement – 814-443-1931
 Wes Stauffer Engine and Equipment – 717-738-4215
 Woodhouse, J. S. – 717-938-5100



Bed Shaper Equipment

Market Farm Implement – 814-443-1931
 Nolt's Produce Supplies – 717-656-9764, 661-7069
 Rain-Flo Irrigation – 717-445-3000

Fertilizer Application Equipment

Market Farm Implement – 814-443-1931
 Mechanical Transplanter – 800-757-5268

STAND 'N PLANT

<h3 style="text-decoration: underline;">SEEDER</h3> <p>Use for...</p> <ul style="list-style-type: none"> • Seeds • Onions • Garlic 	<p><i>Easily plant hundreds of seeds or plants per hour into plastic covered or bare ground seed beds.</i></p>	<h3 style="text-decoration: underline;">PLANTER</h3> <p>Use for...</p> <ul style="list-style-type: none"> • Transplants • Potatoes • Bulbs 
--	--	---

Stand 'N Plant
 95 Rose Road, Saltsburg, PA 15681
 Phone: 724-639-3965 or visit: www.standnplant.com



MaterMacc Precision Vacuum Planters Finally, One Planter For All Seed!

New PushMacc



VegiMacc



MaterMacc

Two row shown with **Easy Set Toolbar** and **Stainless Steel** fertilizer and insecticide hoppers.
Plants All Size Seed from Raw Lettuce to Pumpkin!
Quick Change Row Spacings!
Quick Change Seed Variety!
Quick Fertilizer Clean Outs!
1.5 Thimble Seed Charging!
Ideal for Corn & Pumpkin!

WE ALSO STOCK:

- Transplanters • Rototillers • Sprayers
- Cultivators Bed Shapers • Mulch Layers
- Spading Machines • Veg. Harvesters
- Wash Lines • Potato Diggers

Bean Harvester



3 Point Hitch
with Adjustable
Hydraulic Offset

SOLD BY:

Market Farm Implement, Inc.

257 Fawn Hollow Road • Friedens PA 15541

814-443-1931 | www.MarketFarm.com

• VISITORS BY APPOINTMENT •

VENDORS BY CATEGORY

Two Locations to Serve You Better!



Nolt's Greenhouse Supplies

Specializing in Greenhouse and Nursery Growing Supplies

(717) 354-8376

151 E. Farmersville Road
Ephrata, PA 17522



Nolt's Produce Supplies, LLC

Specializing in Vegetable Growing Supplies and Equipment

(717) 656-9764

152 N. Hershey Avenue
Leola, PA 17540



Compact Raised Bed Mulch Layer



Greenhouses & High Tunnels



Hyd Reset Mulch Lifter

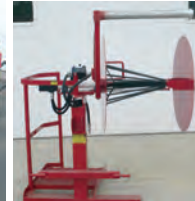

Hyd Drive Wrapper



Water Wheel Transplanter

Please contact us for our free commercial growers catalogs or view it on our website: www.noltsproducesupplies.net

Hillside Cultivator Co. LLC



Hydraulic adjusted cultivator for the edges of plastic mulch



Cultivators especially for Strawberries



Eco Weeder for close cultivation around individual plants

For more information visit hillsidecultivator.com

Contact: John Shenk 717-669-3158 Lititz, PA hillsidecultivator@gmail.com



See us for your weed control needs

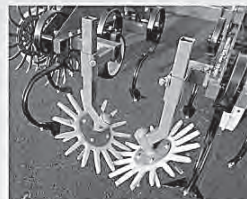

Finger Weeder



Rotary Hoe with Shield



Rotary Hoe with Walking Beam

We also carry:

- Cover Crop Rollers
- Non-plugging
- Sickle Bar Mowers



(717) 442-9451

10 South New Holland Road, Suite 2
Gordonville, PA 17529

VENDORS BY CATEGORY

General Equipment

Planting Equipment

- I & J Manufacturing – 717-442-9451
- Market Farm Implement – 814-443-1931
- Martin’s Produce Supplies – 888-381-8641
- Marvel, Robert, Plastic Mulch – 800-478-2214
- Mechanical Transplanter Co. – 800-757-5268
- Nolt’s Produce Supplies – 717-656-9764, 661-7069
- Rain-Flo Irrigation – 717-445-3000
- Stand’N Plant – 724-639-3965
- Woodhouse, J. S. – 717-938-5100

Plasticulture Equipment

- CropCare – 717-738-7365
- DuBois Agrinovation – 800-667-6279
- Martin’s Produce Supplies – 888-381-8641
- Market Farm Implement – 814-443-1931
- Marvel, Robert, Plastic Mulch – 800-478-2214
- Mechanical Transplanter Co. – 800-757-5268
- Nolt’s Produce Supplies – 717-656-9764, 661-7069
- Rain-Flo Irrigation – 717-445-3000
- Saylor’s Farm Products – 814-745-2306

SAVE TIME AND LABOR
Pro Veyor Harvesting Aid



- :Trailer or wagon style option
- :30 ft aluminum conveyor with paddles 12in apart
- :Conveyor can be moved from front to back with track system
- :Conveyor can be lifted above bins for transporting



Give us a call on how you can purchase your Rohand or visit our website for more information



25 Old Leacock Rd - Ronks Pa 17572
717-768-7619
www.harvestpromfg.com

BCS THE BEST TILLER ON EARTH
No Belts • No Chains • No Equal

PRE SEASON SALE

- 18" To 30" Tilers
- Models 7 To 13HP
- Quick Change Handle Positions
- No Time-Limit Warranty on Transmissions
- 50% Higher Tine Speed Than Competition
- FREE Quick Hitch w/2+ Attachments On 732 To 853

See the Model 770 Hydro

Rotary Plow Power Harrow Brush Mowers Sickle Bar Mowers Snow Throwers

Also: Flail Mowers • Chipper/Shredder • Wood Splitter • Utility Trailer

WES STAUFFER EQUIPMENT LLC
www.wesstauffer.com 717-738-4215
BCS Dealer For 36 Years!

23 Pleasant Valley Rd., East of Ephrata off Rt. 322 • Mon., Wed. & Thurs., 8-5:30; Tues. & Fri., 8-7; Sat., 8-1



VENDORS BY CATEGORY

General Equipment

Harvesting Equipment

- CropCare – 717-738-7365
- Fisher Sprayer Manufacturing – 717-768-7619
- I & J Manufacturing – 717-442-9451
- Market Farm Implement – 814-443-1931
- Martin's Produce Supplies – 888-381-8641
- Nolt's Produce Supplies – 717-656-9764, 661-7069
- Rain-Flo Irrigation – 717-445-3000

Work Smarter Not Harder

Plant, Maintain And Harvest Your Produce



- Fully adjustable operator platform and head support for all day comfort
- Foot- Controlled Variable Speed and steering keeps both hands free for higher production



Give us a call on how you can purchase your Rohand or visit our website for more information



25 Old Leacock Rd - Ronks Pa 17572
717-768-7619
www.harvestpromfg.com

MECHANICAL TRANSPLANTER COMPANY

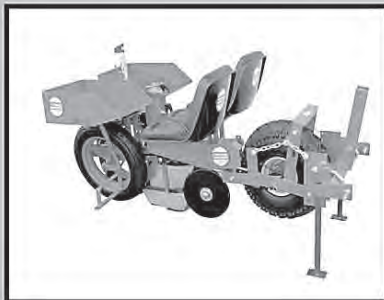

Model 1000

- * Excellent for bare root and small cells. Our most popular transplanter.

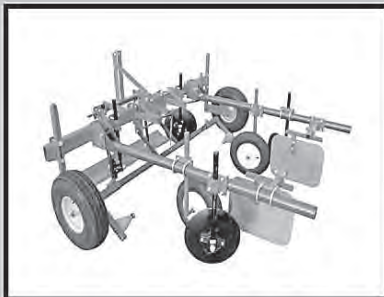

Model 90

- * Lays any size mulch from 3-6 feet wide.

NEW CLEAN SEEDER



MODEL JP-1

- * Excellent for small seed
- * Lightweight & easy to handle
- * Accurate spacing



MODEL JPH

- * Row spacing as close as 7"
- * Mounts on 2" square toolbar

Mechanical Transplanter Company, LLC * 1150 Central Avenue * Holland, MI 49423
Phone: 616-396-8738 or 800-757-5268 * Fax: 616-396-3619
website: www.mechanicaltransplanter.com * e-mail: mtc@mechanicaltransplanter.com

VENDORS BY CATEGORY

General Equipment

Irrigation Equipment and Supplies

DuBois Agrinovation – 800-667-6279
 Gristmill Farm – 717-354-8443
 Harris Seeds – 585-754-5245
 Keystone Fence Supplies – 717-949-8170
 Market Farm Implement – 814-443-1931
 Martin's Produce Supplies – 888-381-8641
 Marvel, Robert, Plastic Mulch. – 800-478-2214
 Nolt's Produce Supplies – 717-656-9764, 661-7069
 Rain-Flo Irrigation – 717-445-3000



MRS AIR BLAST SPRAYER

5 X 5 Spray Head
 Sprays 12-15 Ft.
 on both sides

- > 23 HP Vanguard engine
- > Electric start
- > 60 gallon tank
- > Trailer hook up
- > Electric diaphragm pump

PRODUCED BY

Martin's
 Repair Shop LLC

27 W Mohler Church Rd. Ste
 1 Ephrata, PA 17522
 717-733-3015

**SEE VIDEOS OF SPRAYERS IN ACTION ON UPDATED WEBSITE!
 NEW HYDRAULIC FOLD SPRAYER FEATURES
 AIRBAG BOOM SUSPENSION!**



200, 300 & 400 Gal. Manual Fold • 300 & 400 Gal. Hyd. Fold

Ask us about the advantages of the front mount boom.

PENNS CREEK MFG.

1340 Broadway Rd., Winfield, PA 17889

570-837-1197

www.pennscreekwelding.com

BUILDERS OF DEPENDABLE ECONOMICAL VEGETABLE SPRAYERS

VENDORS BY CATEGORY

General Equipment

Pesticide Application Equipment

- CropCare – 717-738-7365
- Fisher Sprayer Manufacturing – 717-768-7619
- Market Farm Implement – 814-443-1931
- Martin’s Produce Supplies – 888-381-8641
- Martin’s Repair Shop – 717-733-3015
- Penns Creek Welding – 570-837-1197
- Woodhouse, J. S. – 717-938-5100



DVTS CANNON SPRAYER

- Great for vegetables, grain, vineyards, and fruit trees
- Effective range of horizontal treatment up to 131 ft.
- Hydraulic left-right rotation from +85° to -15°
- Flexible variable hydraulic inclination
- Proportional distribution
- 20” double fan and fourteen jets
- Lift-mounted tanks from 105 to 264 gal. and trailed from 264 to 1056 gal.

Teyme’s Cannon Sprayers are designed for application from a distance, allowing for the treatment of difficult to access crops.

Teyme’s Airblast Sprayers are efficient and cost-effective, reducing drift as well as application time.



ASM1 AIRBLAST SPRAYER

- Great for vineyards and fruit trees
- Lift-mounted machine with reinforced steel frame
- High density polyethylene tanks from 53- 158 gal.
- Two levels of mixing (pressure/return) achieve a constant and homogeneous mixture.
- Rinsing auxiliary tank (10%) and sanitary water tank
- 3-Point air flow rates up to 45,438 CFM
- 3-Point air units from 24” to 32”
- Three levels of filtering

DISTRIBUTED BY:
J. S. WOODHOUSE CO. INC.
 1314 Union Street
 West Springfield, MA, 01089
 Phone: (413) 736-5462
 Email: info@jswoodhouse.com
 Website: www.jswoodhouse.com

J.S. Woodhouse Co., Inc. Since 1843
WOODHOUSE
 A Division of Hayward Distributing Co.

VENDORS BY CATEGORY

General Equipment

Grading, and Packing Equipment

Market Farm Implement – 814-443-1931
 Martin's Produce Supplies – 888-381-
 Nolt's Produce Supplies – 717-656-9764, 661-7069
 Rain-Flo Irrigation – 717-445-3000
 Tew Manufacturing Corp. – 800-380-5839

Wholesale Labeling Equipment

Texpak – 800-645-3416

Refrigeration and Storage Systems

Arctic Refrigeration – 585-343-2678
 KoolJet Refrigeration – 866-748-7786



Refrigerated and Ventilated Cooling Systems for Fruit and Vegetable Storages

- COMMERCIAL REFRIGERATION
- DESIGN, SALES AND SERVICE
- SERVING AGRICULTURE
FOR OVER 70 YEARS

Free Consultation and Quote
 Call Mike Mager at 585-343-2678

See Us At
 Booth #78 At
 The Mid-Atlantic
 Fruit & Vegetable
 Convention

ARCTIC

REFRIGERATION CO. OF BATAVIA

26 Cedar Street, Batavia, NY 14020
www.arcticrefrigeration.com

Since 2001 Authority in Refrigeration for
 Agro-Industrial Applications in North America.



- Thru the Wall
- Portable
- Roof Mounted
- Hydrocoolers
- Custom Designs
- Blast Freezers
- Chillers
- Greenhouse
Coolers



1.866.748.7786
info@kooljet.com

VENDORS BY CATEGORY

TEW MANUFACTURING CORP.

Fruit & Vegetable Cleaning &
Sizing Equipment & Parts

Quality Latex & Poly Sponge
Rubber Drying Donuts

Tuff Foam® Protective Padding

Brushes • Bearings • Sizing Chains

Belting • Scrubber Rubber

New Stainless Steel Machines

**CALL TOLL FREE 800-380-5839
FOR CATALOG & PRICES**

TEW MFG. CORP. 585-586-6120
P.O. BOX 87 FAX: 585-586-6083
PENFIELD, NY 14526 www.tewmfg.com

2 DAY PUBLIC AUCTION SCHRAMM FARMS & ORCHARDS Complete Business Liquidation

*Western PA's premier Vegetable Grower.
Vegetable Greenhouse & Nursery Operation*

Located: 1002 Blank Road, Jeannette, PA 15644
(Approx. 35 Miles E. of Pittsburgh, off US Rt 22 E).

Saturday: April 2nd Starting 9:00 am.

Full Line Of Farm Machinery: 8 Tractors: Ford Mod 6610 Diesel, Ford Mod TW-10 diesel w/ cab, 7900 hrs, N H Mod 1920 O-RPS, 2014 N H Mod T4.75, 4WH, diesel cab, 2776 hrs, N H TT75A, 4WH, diesel 0-ROPS, 1564 hrs, Ford Mod 5640 diesel, cab, New Holland TN65D Diesel w/ cab, 4916 hrs, Ford Mod 1710 2021 hrs. **Tillage equipment:** Ford Mod. 151 5 Bottom Plow, JD Mod. 7200, 4 row Corn Planter, N H Mod. 644 Round Bailer, N H Mod. BC5050 Sq. Bailer (Like New), 2015 Tomahawk 5050 Bale Buster, Maschio Mod 300, Condor SC, 10' Spike Tooth tiller, w/ Howard HR20 10' rotovator, Heston Mod. 1110 hay bine, N I Single Row Corn Picker, J & M Gravity Wagon, Gravity box w/ Kory 6072 running gears, Spike Tooth Bale Elevator, Approx. 100, 2021, Clean, Rye, Barn Kept Rd Bales, Approx 100 Sq Bales Straw, Bale King Type Wagons, Flat Wagons, Special Custom Built "Hay Ride / Transport Wagon" W/Built In Steps, Kuhn Hay Rake, Orchard Mower, 2005 Int. 4300 DT 466, 285,170k miles Pick-Up Trucks list to follow.

Saturday: April 9th Starting 9:00 am.

Irrigation Equipment: 2019 ABI Traveler Irrigation system 650' hose cart & Komet Mod 101 Big Gun Water Canon, Kiffco Caprari 3 pt. hitch irrigation pump, 30" sections of 2"-3"- 4" Alum. Irrigation Piping, 2", 3", 4" sprinklers, misc. alum pipe fittings, large quantity of Drip/Trickle Irrigation system, Orchard plastic drip line vegetable irrigation system, plastic drip line winder, Rain Flo Mod 2550 Series 2 plastic mulch layer, Rain Flo Mod 1600, Vegetable trans planter, w/ 9", 18", 24", 32" planting wheels, Holland single row vegetable trans planter, Berthoud Super Air Flow 500 liters (132 gallons) sprayer, PTO driven, Weed Badger Mod 2550SS1, 3 pt. hitch "In Row" tiller, Challenger Mod 1800 plastic lifter, propane multi bang bird guns, used plastic pick up/roller Iron Age (York, PA) steel wheel Potato Planter, 2- John Deere corn binders, Produce Pack Machinery Co. Mod SAS24B, 24" wide conveyor, s/n 9549 03-13, potato grader, 2 rolls of new 35' x 1000' row cover & cover addition bundles of used crop cover, hydraulic bulk bin/container transporter, Conkin Field Bin hydraulic bin Trailer, **Picking/Packing Equipment:** approx. 100- 45" x48" wooden stacking & 100 plastic bulk boxes, approx., Gaylord Type Bulk boxes, hand held picking containers, round plastic nesting, cardboard produce boxes, **11 Hoop houses**, Komatsu Propane Forklift, Crown Battery Operated pallet jack w/ charger, 2748/5500 lb, cap Pallet Jacks, Follett Ice Machine, chest freezers, proof racks, misc. wheeled carts, scales, 8' x 16' walk in cooler, etc.

Terms: Cash, Checks, Credit Card: 3% processing fee.
VISIT WEB FOR FULL LIST & PHOTOS

www.markferryauctioneers.com

Mark Ferry Auctioneers, Inc.

724-423-5580 AY 2076

Mark L. Ferry and Randy Betton

Members of PAA & NAA



VENDORS BY CATEGORY

General Supplies

Mulching/Row Covers

DuBois Agrinovation – 800-667-6279
 Gristmill Farm – 717-354-8443
 Harris Seeds – 585-754-5245
 Martin's Produce Supplies – 888-381-8641
 Marvel, Robert, Plastic Mulch – 800-478-2214
 Mechanical Transplanter Co. – 800-757-5268
 Nolt's Produce Supplies – 717-656-9764, 661-7069
 Rain-Flo Irrigation – 717-445-3000

Fertilizer

Fertrell Company – 717-367-1566
 Martin's Produce Supplies – 888-381-8641
 Nolt's Produce Supplies – 717-656-9764, 661-7069
 PA Service & Supply – 717-334-6129



**ROBERT MARVEL
 PLASTIC MULCH, LLC**

717-838-0976
www.robertmarvel.com

Healing the Earth and Feeding the World - Better Naturally!

**Natural and Organic
 Fertilizers & Feed Supplements**

75TH ANNIVERSARY

Fertrell®

SINCE 1946

Better Naturally!

**CONTACT US FOR A COPY OF OUR NEW CATALOG! CALL OUR OFFICE: 800-347-1566
 EMAIL US AT INFO@FERTRELL.COM OR VISIT US ONLINE AT WWW.FERTRELL.COM**

VENDORS BY CATEGORY

BiO 360
Biodegradable | Compostable Mulch Film®

MATER-BI Made from Mater-Bi

COMPOSTABLE
BPI Certification

No negative impact on soil

Suitable for many types of crops

Several thicknesses available

Sustainably produced

Nolt's Produce Supplies
717-656-9764 - Leola, PA
noltsproucesupplies.net
For other regions, contact us
1-844-4BIO360 (1-844-424-6360)

EXPERIENCE
15 YEARS
SUCCESS MOH-MONY

BiO 360
Biodegradable | Compostable Mulch Film

VENDORS BY CATEGORY

General Supplies

Pesticides/Plant Growth Regulators

- Certis USA – 800-250-5024
- Fertrell Company – 717-367-1566
- FMC – 717-304-8957
- Martin's Produce Supplies – 888-381-8641
- Marrone Bio Innovations – 717-877-7105
- Vive Crop Protection – 616-928-8720

Biocontrols – Beneficial Insects

- Certis USA – 800-250-5024
- IPM Laboratories – 315-497-2063
- Marrone Bio Innovations – 717-877-7105

Cover Crop Seeds

- King's Agriseeds – 717-687-6224

Your SOURCE for Produce and Greenhouse Supplies.

- Seeds
- Potting Soil
- Peat Moss
- Greenhouses
- Fertilizers
- Irrigation
- Pots and Planters
- Row Covers
- and much more!

1-888-381-8641
(717) 532-5918
Call for your free catalog

Effective & Sustainable

Double Nickel 55
BIOFUNGICIDE

Copper 29
Cu eva

LIFE GARD[®]
BIOLOGICAL PLANT
ACTIVATOR

Three biological solutions for proven protection against fungal and bacterial diseases in cucurbits, leafy vegetables, fruiting vegetables, cole crops, root and bulb crops, and legumes.

Learn more at www.CertisBio.com

1-800-250-5024
www.CertisBio.com

VENDORS BY CATEGORY



OUTSTANDING

SEED COMPANY, LLC[®]

B R E E D E R | P R O D U C E R

Outstanding Seed is an innovative seed company specializing in breeding, production, and marketing of proprietary, large handled, high yield potential, Powdery mildew resistant pumpkin, gourd, and winter squash hybrids.

Outstanding Seed stacking pumpkin hybrids offer improved vigor and yield potential, unique colors and color patterns, unique rind textures, and therefore improved profit potential.

Over fifty hybrids are available to meet many different needs. Call today to place an order or request our 2022 Catalog.

Daybreak^{F1}

- Large, flat, multi-hued, lobed fruit, great for stacking.
- Shades of mostly reddish orange.
- Some fruit have marbled patterns of blue. Other colors and color patterns may occur.
- Some fruit may have a rough, bumpy rind texture.
- Strong Powdery mildew resistance.
- Excellent yield potential.
- FarMore[®] treated seed and untreated seed are both available.



VENDORS BY CATEGORY

General Supplies

Containers and Packaging Supplies

- DuBois Agrinovation – 800-667-6279
- Harris Seeds – 585-754-5245
- Martin's Produce Supplies – 888-381-8641
- Nolt's Produce Supplies – 717-656-9764, 661-7069
- ProducePackaging.com – 800-644-8729
- Putnam Plastics – 800-457-3099
- Saylor's Farm Products – 814-745-2306
- Statewide Bag Service – 717-647-2623

Wildlife/Bird Damage Control Products

- DuBois Agrinovation – 800-667-6279
- Marvel, Robert, Plastic Mulch – 800-478-2214

Trellising/Fencing Supplies/Equipment

- Keystone Fencing Supplies – 717-949-8170



ProducePackaging.com[®]
for all your produce packaging needs

1-800-644-8729
 Kurt Zuhlke & Assoc., Inc.
 P.O. Box 609, Bangor, PA 18013



Over 45 Years In The Industry

For over 45 years, Kurt Zuhlke & Assoc., Inc. has been a part of the many innovative packaging concepts utilized by the produce industry.



High Quality Products And Services

Our packaging is designed to protect produce, provide excellent visibility to the consumer, reduce shrinkage and enhance the product. We also offer professional labeling design and application.



From Farmers To Repackers

Whether you are ordering a case or a truck load, you can rest assured that we have the ability and capacity to service your orders quickly.



VENDORS BY CATEGORY



LEMONADE

Lemonade is a bright eye-catching pumpkin with a golden touch. It offers high yields of 16-20lb, uniform, medium sized fruits on a strong vine for superior performance.



FIREBALL

Fireball is an explosive addition to any patch! It offers excellent yields with good post-harvest holding with consistent results time and time again for a trusted crop.



KRATOS

Kratos is a strong 20-30 lb standout in the patch. Its large firmly attached handle is perfect for picking while its high yield potential is great for increased profits.



RED DEUCE

Red Deuce is a beautiful vibrant vine-ripe tomato with exceptional quality. It has a medium vigor plant with good foliage cover for a quality harvest.



PONY EXPRESS

Pony Express offers a perfect combination of earliness and high yields. Its early compact plant produces a very concentrated high pack out of large to extra-large fruit.



TRIBUTE

Tribute is a dark green zucchini with a medium upright plant and open vine that produces high yields of straight cylindrical fruit. A great choice with a strong disease package.

For more information, call:
Nolt's Produce Supplies, LLC • (717) 656-9764
 152 North Hershey Avenue, Leola, PA 17540-9711

VENDORS BY CATEGORY

Vegetable Supplies

Vegetable Seeds

Harris Seeds – 585-754-5245
 Martin's Produce Supplies – 888-381-8641
 Nolt's Produce Supplies – 717-656-9764
 Outstanding Seed Co. – 800-385-9254
 Rupp Seeds – 419-337-1841
 SeedWay – 800-952-7333
 Stokes Seeds – 800-263-7233

Vegetable Plants

Harris Seeds – 585-754-5245
 Re-Divined – 717-875-6644

After 10 years in business...

Let our lessons learned through the years
 pave the way for your success. We supply
custom orders of GRAFTED plants
 including: Tomato, Pepper, Eggplant and
 Watermelon.



Mike and Kaitlin Horst

142 Black Swamp Rd.

Bainbridge, PA 17502

717-286-7658 ✱ grafted@redivined.net

Call or write and request our 2022 price list

No charge for deliveries within Lancaster Co



Paper & Poly Potato Bags
 Mesh Bags for Onions, Cabbage & Sweet Corn
 Fischbein Sales & Service
 Thread & Wire Ties



Large inventory of Produce Packaging
 2lb. to 50 lb. Paper Potato Bags
 Paper Master Containers
 Poly Potato Bags
 3 lb. 10 lb. 25lb. & 50 lb. Mesh Onion Bags
 Mesh Cabbage & Mesh Sweet Corn Bags
 Wire Ties & Kwik Loks
 Fischbein Portable Bag Closers
 Fischbein Parts & Repairs done on site
 Thread / 8 oz. to 20 lb. Cones
 CALL

717-647-2623 -717-460-7962

Visit our website at

www.tallmanpotatoes.com

see our full line of products

CALL STATEWIDE BAG SERVICE

FOR YOUR

PRODUCE PACKAGING NEEDS

HIGH QUALITY PRODUCTS

& PERSONALIZED SERVICE

sjtallman@tallmanpotatoes.com

VENDORS BY CATEGORY

PLANT. PICK. PROFIT.



NEW

XANADU • 75 DAY BICOLOR SH2 SWEET CORN

Fantastic eating quality. A crisp bite into high sugars! This also has excellent seed quality and vigor from the sh2i gene. Large ears on a plant with a good disease package. HR: Ps (Rp1GFJ) IR: Et

YOUR ACRES. YOUR LIVELIHOOD. OUR PRIORITY.

EXPRESSION • 105 DAY INTERMEDIATE DAY ONION

Intermediate day hybrid. Large, firm sweet onion balanced with good onion flavor so it is enjoyed both raw and cooked. Performs well from transplants in Northern areas. Short to medium term storage. Thinner neck and higher disease package than competition, helping prevent internal and external quality issues. HR: PR ; IR: FBR

CANARIO REAL • 74 DAY HOT BANANA PEPPER

Main season, hot banana pepper. Vigorous plant habit. Large and heavy fruits. Canario Real is a banana pepper with high marketable fruit yield for more profit. HR: PVY:0,1

SWEET BABY JANE • 105 DAY LARGE PUMPKIN

We are pleased to add Sweet Baby Jane to our lineup! Sweet Baby Jane has shown consistent setting ability in our trials from NC to IN and North. Long, sturdy handle, and distinct ribbing completes an eye-catching, ready-to-market pumpkin that is appealing to roadside and retail markets. 15-25 lbs. IR: PM

BOCA • 73 DAY BELL PEPPER

This SEEDWAY exclusive is impressing growers where Xcv 1-10 races are needed. The fruit is very dark green with thick, firm walls. Boca is unique in that it also has TSWV in addition to Bacterial Leaf Spot resistance and retail markets. Plant is sturdy with good cover. HR: Xcv (1-10) / IR: TSWV



EXPRESSION



CANARIO REAL



SWEET BABY JANE



BOCA



99 INDUSTRIAL AVE
ELIZABETHTOWN, PA 17022



(800) 952-7333



WWW.SEEDWAY.COM

VENDORS BY CATEGORY

Small Fruit Supplies

Berry Nurseries

Maplewood Produce Greenhouse – 717-532-3278

Nourse Farms, Inc. – 413-665-2658



Photo – Kathleen Demchak

NOURSE
Delivering Quality

High-quality plants.
Exceptional customer service.

**It's our mission.
Literally.**



NourseFarms.com | 413-665-2658 | info@noursefarms.com

STRAWBERRY PLANTS

Plugs for
August & September Planting
Varieties Available:

Sweet Charlie Galletta Chandler

Flavorfest Camarosa Camino Real

Keepsake Ruby Jane Malwina Sensation

Day Neutral:

Albion San Andreas

Tips are harvested from
tissue-cultured plant stock.

**Pick Up - Delivered
Can Ship Motor Freight or FedEx**

Maplewood Farm Market, LLC

Reuben R. Martin

717-532-3278

VENDORS BY CATEGORY

RAISING THE BAR

Have you been Frightened? **Fright** is a new standard in warted pumpkins. This hardshell **Rupp** pumpkin stays looking fresh in your fall displays.



FRIGHT 



TEMPO XR

Tempo XR is a 76 day bi-color SH2 sweet corn that has a great ear size for mid-season roadside and fresh markets. This **IFSI**, rust resistant variety provides excellent husk protection and consistent tip fill across varying environmental conditions.



THUNDERSTRUCK

Thunderstruck is a new melon from **Seneca Vegetable Research** with outstanding Eastern flavor, sugar levels, and texture. Full slip, full color change aids in an easier harvest. Fruit provide enhanced holding ability giving you extended time to market.



STM2255

STM2255 is a very versatile and adaptable determinate salad variety tomato from **Sakata**, with high yield potential and good vine-ripe flavor. Fruit have an attractive red color, firm and provide good shelf-life.

RAISING THE BAR IN QUALITY, FLAVOR, AND YIELD

Bringing you the best products in partnership with **IFSI**, **Sakata**, and **Seneca Vegetable Research**.

Visit ruppseeds.com to request or download your copy of our 2022 catalog including 36 new products.



SEE WHAT
GOOD YIELDS®
800-700-1199

Serving
farmers
since
1946

75
Years

ruppseeds.com

VENDORS BY CATEGORY

Greenhouse Supplies & Equipment

Greenhouse Equipment and Supplies

DuBois Agrinovation – 800-667-6279
 Fertrell Company – 717-367-1566
 Gristmill Farms – 717-354-8443
 Harris Seeds – 585-754-5245
 IPM Laboratories – 315-497-2063
 Keystone Fence Supplies – 717-949-8170
 Lambert Peat Moss – 888-632-8808
 Martin's Produce Supplies – 888-381-8641
 Martin's Repair Shop – 717-733-3015
 Marvel, Robert, Plastic Mulch – 800-478-2214
 Nolt's Greenhouse Supplies – 717-354-8376
 Rimol Greenhouse Systems – 603-494-5775

Bedding Plant Seeds/Plugs/Cuttings

Harris Moran Seeds – 209-579-7333
 Harris Seeds – 585-754-5245
 Stokes Seeds – 800-263-7233

Greenhouse and Low/High Tunnel Structures

Nolt's Greenhouse Supplies – 717-354-8376
 Rimol Greenhouse Systems – 603-494-5775

Growing Media

Gristmill Farms – 717-354-8444
 Lambert Peat Moss – 888-632-8808
 Martin's Produce Supplies – 888-381-8641
 Nolt's Greenhouse Supplies – 717-354-8376

Direct Marketing Supplies

Prepared Foods

Gardner's Pies – 717-629-4225

CBD Products

Farmulated – 814-796-7082

Farm Market Packaging

Harris Seeds – 585-754-5245
 Statewide Bag Service – 717-647-2623

Advertising and Promotional Materials

PA Veg. Mktg. & Research Prog. – 717-694-3596

Mobile Apps

Culineer – 717-805-2763

lambert

**PREMIUM PROFESSIONAL
PEAT-BASED SUBSTRATES**



**FOR ALL YOUR GERMINATION
AND ALL PURPOSE NEEDS**



JEFFREY P. BISHOP
 Cell: (315) 480-1900
 Toll Free: (888) 632-8808
 lambertpeatmoss@aol.com
 www.lambertpeatmoss.com

Your Source for . . .

HIGH TUNNELS



**Call Harry Edwards @ 717.606.8021
or Email hedwards@rimol.com**

VENDORS BY CATEGORY



PENNSYLVANIA VEGETABLE MARKETING & RESEARCH PROGRAM

2301 N. Cameron St., Harrisburg, PA 17110 | 717-694-3596 | pvrmp@embarqmail.com | PAVeggies.org

Step Up Your Marketing

with these Point of Purchase Materials designed especially for Pennsylvania Growers



The Pennsylvania Vegetable Marketing and Research Program offers the above selection of point-of-purchase items. Most feature the “PA Produce” logo or tagline to clearly identify your market’s produce as locally grown with these attractive and professionally-designed pieces. Check out these items and the other farmer resources from the Program in the “Farmer’s Toolkit” at www.paveggies.org or call 717-694-3596

VENDORS BY CATEGORY

Services

Associations

Pennsylvania Association for Sustainable Agriculture – 814-349-9856

Pennsylvania Vegetable Growers Association – 717- 694-3596

Auctioneers

Pirring Auctioneers – 585-728-2520

Crop Insurance

Morrissey, Bernard, Insurance – 800-422-8335

Financial Services

AgChoice Farm Credit – 800-998-5557

MidAtlantic Farm Credit – 888-339-3334

General Insurance (Liability, Workers Compensation, Health, Fire, etc.)

Agri-Services Agency – 724-449-6333

Morrissey, Bernard, Insurance – 800-422-8335

Government

Pennsylvania Department of Agriculture – 717-705-9511

Management Services/Products

Martin's Produce Supplies – 888-381-8641

Produce Auctions

Buffalo Valley Produce Auction – 570-966-1151
 Countryside Produce Auction – 814-662-2222
 Cumberland Valley Produce Auction – 717-530-5007
 Juniata Wholesale Produce Sales LLC – 717-463-2484
 Kutztown Produce Auction – 610-683-7161
 Lebanon Produce Auction – 717-367-8379
 Leola Produce Auction – 717-656-9592
 Morrison's Cove Produce Auction – 814-793-9384
 New Wilmington Produce Auction – 724-946-8540
 Oxford Produce Auction – 610-392-2722
 Shippensburg Produce Auction – 717-532-5511
 Smicksburg Produce Auction – 814-221-5103, 229-0056
 Snyder County Produce Auction – 570-374-0284
 Sugar Valley Produce Auction – 570-725-2000
 Sunnyburn Produce Auction – 717-862-3010
 Weaverland Produce Auction – 717-355-0834

DIVERSIFIED VEGETABLE APPRENTICESHIP

Diversified Vegetable Apprenticeship pairs beginning farmers with established growers to provide a guided pathway toward managing or starting a vegetable farm.

Apprentices receive 2,700+ hours of **paid, on-the-job training** & 200+ hours of related coursework over 18 months.

Host farms train the next generation of sustainable farmers & **gain access to a pool of pre-qualified employees** invested in farming as a career.

Apply now at pasafarming.org/dva

Applications for host farms & apprentices are reviewed on a rolling basis, however we recommend applying by **February 25, 2022**.

Pasa
SUSTAINABLE AGRICULTURE



Diversified Vegetable Apprenticeship is administered in Pennsylvania and the surrounding region.

North Star Orchard, Pennsylvania

VENDORS BY CATEGORY



**THINK LIKE A
 GROWER**

We are here with you through every stage of the growing season.

When you're ready to take your operation to new heights, give us a call at 833.277.7443.

 **FARM CREDIT**
 AGCHOICE | MIDATLANTIC
 farmcredit.com

Morrissey Insurance is proud to represent an industry as hardworking and dedicated as our farmers!
We are pleased that our customers choose to work with us!
Customer satisfaction is our number one goal.

Here's what one of our valued customers has to say when asked:

“Why do you choose to work with Morrissey Insurance?”

“Morrissey is a family owned and operated business that understands the needs of our family farm and retail business. Their staff is very knowledgeable and helpful and can provide us with the various types of insurance our farm and retail business needs to keep us “safe” doing business in the Lehigh Valley. We have been with Morrissey for many years and are very happy with the service they provide.”

Newhard Farms



B&M MORRISSEY INSURANCE
 “Insuring Your Future since 1971”

890 N. Reading Rd., Ephrata, PA 17522
 13025 Route 6, Troy, PA 16947
 www.insuringyourfuture.com
800-422-8335

VENDORS BY NAME

Vendors by Name

AgChoice Farm Credit *see ad on page 25*

900 Bent Creek Blvd., Mechanicsburg, PA 17050
888-998-5557
www.agchoicefarmcredit.com

Agri-Services Agency

1008 Applejack Dr., Gibsonia, PA 15044
724-449-6333 or 724-272-3980
www.AgServAgency.com

Arctic Refrigeration Co. *see ad on page 10*

26 Cedar St., Batavia, NY 14020
585-343-2678
www.arcticrefrigeration.com

Buffalo Valley Produce Auction

Violet Road, Mifflinburg, PA 17844
570-966-1151 fax 570-966-2601
www.buffalovalleyproduce.com/

CertisUSA *see ad on page 14*

9145 Guilford Rd., Ste 175, Columbia, MD 21046
800-250-5024
www.CertisUSA.com

Countryside Produce Auction

1695 Savage Rd., Salisbury, PA 15558
814-662-2222

CropCare

295 Wood Corner Rd., Lititz, PA 17543
717-738-7365 fax – 717-738-7375
www.cropcareequipment.com

Culineer

6511 Windmere Rd, Harrisburg PA 17111
717-805-2763
https://culineerapp.com

Cumberland Valley Produce Auction

101 Springfield Rd., Shippensburg, PA 17257
717-530-5007
cvproduceauction.com

Dubois Agrinovation, Inc. *see ad on page 13*

478 Notre Dame, St-Remi, Quebec, Canada J0L2L0
800-667-6279
www.duboisag.com

Farmulated

817 Rt 97, Waterford, PA 16441
814-796-7082
www.farmulated.com

Fertrell Company *see ad on page 12*

PO Box 265 Bainbridge PA 17502-0265
717-367-1566
www.fertrell.com

Fisher Sprayer Manufacturing *see ads on page 6 and 7*

25 Old Leacock Rd., Ronks, PA 17572
717-768-7619
www.proveyorwagon.com

FMC

Michael Myers, Retail Market Manager
717-304-8957
michael.myers@fmc.com www.FMCcrop.com

Frecon Orchard Supply

501 South Reading Ave., Boyertown, PA 19512
610-367-2933

Gardner Pie Co

3077 N Colebrook Road, Manheim, PA 17545
717-629-4225
Kevin.Hickernell@gargnerpie.com

Gowan Co

Alex Deckey, Sales Rep
845-745-9246
adeckey@gowanco.com
www.gowanco.com

Gristmill Vegetable Farm

201 Gristmill Rd, New Holland PA 17557
717-354-8444 fax – 717-354-8444

Harris Seeds

355 Paul Road, Rochester, NY 14624
800-544-7938 fax – 877-892-9197
www.harrisseed.com

Harris Moran Seed Co. *see ad on page 17*

555 Codoni Avenue, Modesto, CA 95357
209-579-7333 fax – 209-544-0335
www.harrismoran.com

Hillside Cultivator *see ad on page 5*

911 Disston View Dr., Lititz, PA 17543
717-626-6194
www.hillsidecultivator.com

I & J Manufacturing *see ad on page 5*

5302 Amish Rd., Gap, PA 17527
717-442-9451
www.farmingwithhorses.com

IPM Laboratories

PO Box 300, Locke, NY 13092-0300
315-497-2063, fax - 315-497-3129
www.ipmlabs.com

Juniata Wholesale Produce Sales LLC

4655 Cedar Springs Rd., Mifflintown, PA 17059
717-463-2484

Keystone Fence Supplies, LLC

PO Box 268, 280 N. Locust St., Schaefferstown, PA 17088
717-949-8170
www.keystonefencesupplies.com

King's Agri-Seeds

1828 Freedom Rd, Lancaster, PA 17601
717-687-6224
www.kingsagriseeds.com

KoolJet Refrigeration *see ad on page 10*

150 Adams Blvd., Brantford, ON N3S 7V2
866-748-7786 fax – 519-452-4040
www.kooljet.com

VENDORS BY NAME

Kutztown Produce Auction

209 Oakhaven Rd., Fleetwood, PA 19522
610-683-7161 fax 610-683-5429
www.kutztownproduceauction.com

Lambert Peat Moss *see ad on page 22*

106 Lambert Rd., Riviere-Ouelle, QU Canada G0L 2C0
888-632-8808, 315-480-1900
www.lambertpeatmoss.com

Lebanon Produce Auction

166 W. Reistville Rd., Myerstown, PA 17067
717-949-2643
www.lebanonproduceauction.com

Leola Produce Auction

135 Brethren Church Rd., Leola, PA 17540
717-656-9592
www.leolaproduceauction.com

Maplewood Produce Greenhouse *see ad on page 20*

8564 Old Scotland Rd., Shippensburg, PA 17257
717-532-3278

Market Farm Implement *see ads on page 4*

257 Fawn Hollow Rd., Friedens, PA 15541
814-443-1931
www.MarketFarm.com

Marrone Bio Innovations

1540 Drew Ave., Davis, CA 95618
717-877-7105
www.marronebio.com

Martin's Produce Supplies *see ad on page 14*

627 Britton Rd., Shippensburg, PA 17257
888-381-8641 fax - 717-532-5872
www.martinsproducesupplies.com

Martin's Repair Shop *see ad on page 8*

28 E. Trout Run Rd., Ephrata, PA 17522
717-733-3015, fax - 717-733-9618

Marvel Plastic Mulch-Irrigation, Robert *see ad on page 12*

2425 Horseshoe Pike, Annville, PA 17003
800-478-2214, fax - 717-838-0978
www.RobertMarvel.com

Mechanical Transplanter Co. *see ad on page 7*

1150 Central Ave., Holland, MI 49423-5230
800-757-5268, fax - 616-396-3619
www.mechanicaltransplanter.com

MidAtlantic Farm Credit *see ad on page 25*

45 Aileron Ct, Westminster, MD 21157
888.339.3334
www.maafc.com

Morrison's Cove Produce Auction

174 Windy Acres Ln., Roaring Springs, PA 16673
814-793-9384

Morrissey Insurance Inc. , Bernard *see ad on page 25*

890 N. Reading Rd., Ephrata, PA 17522
800-422-8335, fax - 717-336-3729
www.insuringyourfuture.com

Nolt's Greenhouse Supplies *see ad on page 5*

151 E. Farmersville Rd., Ephrata, PA 17522
717-354-8376
www.noltsgreenhousesupplies.com

Nolt's Produce Supplies *see ads on pages 5, 13 & 17*

152 North Hershey Ave., Leola, PA 17540
717-656-9764
www.noltsproducesupplies.net

Nourse Farms, Inc. *see ad on page 20*

41 River Rd, South Deerfield, MA 01373
413-665-2658, fax - 413-665-7888
www.noursefarms.com

Outstanding Seed Co. LLC *see ad on page 15 and insert*

PO Box 202, Monaca, PA 15061
800-385-9254
www.outstandingseed.com

Oxford Produce Auction

200 Union School Rd., Oxford, PA 19363
610-392-2722

PA Farm Markets, LLC

4184 Dorney Park Rd., Room 104, Allentown, PA 18104
610-391-9840
www.pafarm.com

Penns Creek Welding & Manufacturing *see ad on page 8*

1340 Broadway Road, Winfield, PA 17889
570-837-1197
www.pennscreekwelding.com

Penna. Department of Agriculture

2301 N Cameron St., Harrisburg, PA 17110-9408
717-409-0219
agriculture.pa.gov/agbiz

PA Preferred Program

2301 N Cameron St., Harrisburg, PA 17110-9408
717-705-9511
www.papreferred.com

Penna. Ass'n. for Sustainable Ag. *see ad on page 24*

PO Box 419, Millheim, PA 16854
814-349-9856, fax - 814-349-9840
www.psafarming.org

Penna. Vegetable Marketing and Research Program

see ad on page 23
2301 N. Cameron St., Harrisburg, PA 17110
717-694-3596
www.paveggies.org

Pirring Auctioneers, Inc.

PO Box 607; 2731 East Naple Street; Wayland, NY 14572
585-728-2520, fax - 585-728-3378
www.pirringinc.com

ProducePackaging.com *see ad on page 16*

PO Box 609; 20 Market St., Bangor, PA 18013
800-644-8729
www.producepackaging.com

Rain-Flo Irrigation

929 Reading Rd., East Earl, PA 17519
717-445-3000, fax - 717-445-8304
www.rainfloirrigation.com

VENDORS BY NAME

Re-Divined *see ad on page 18*

142 Black Swamp Rd, Bainbridge, PA 17502
 717-286-7658 grafted@redivined.net
 www.redivined.weebly.com

Rimol Greenhouse Systems *see ad on page 22*

40 London Derry Tpk., Hooksett, NH 03106
 717-606-8021, fax – 603-629-9023
 www.rimol.com

Rupp's Seeds *see ad on page 21*

17919 Road B, Wauseon, OH 43567
 419-337-1841, fax – 419-337-5491
 www.ruppseeds.com

Saylor's Farm Products

17319 Rt 68, Sligo, PA 16255
 814-745-2306
 www.saylorsfarm.com

SeedWay *see ad on page 19*

99 Industrial Rd., Elizabethtown, PA 17022
 800-952-7333, fax - 717-367-0387
 www.seedway.com

Shippensburg Produce Auction

1120 Ritner Hwy., Shippensburg, PA 17257
 800-346-2334
 sauctioncenter.com

Smicksburg Produce Auction

1526 Barnard Rd., Smicksburg, PA 16256
 814-221-5103 or 814-229-0056

Snyder County Produce Auction

6130 S. Susquehanna Trail, Port Trevorton, PA 17864
 570-374-0284 fax 570-374-0693
 www.snydercountyproduce.com

Stand'N Plant *see ad on page 4*

95 Rose Rd., Saltsburg, PA 15681
 724-639-3965 or 724-349-5167
 www.standnplant.com

Statewide Bag Service *see ad on page 18*

31 Schwalm Road Tower City PA 17980
 717-647-2623
 www.tallmanpotatoes.com

Stokes Seeds

Box 548, Buffalo, NY 14240
 800-263-7233, fax – 888-834-3334
 www.stokeseeds.com

Sugar Valley Produce Auction

702 South Mill St., Loganton, PA 17747
 570-725-2000

Sunnyburn Produce Auction

101 Atkins Rd., Airville, PA 17302
 717-862-3010

Tew Manufacturing Corp. *see ad on page 11*

PO Box 87; 470 Whitney Rd.; Penfield, NY 14526
 800-380-5839, fax 585-586-6083
 www.tewmfg.com

Texpak

130 Hyde Park Rd., Franklin Square, NY 11010
 800-645-3416
 www.texpack.com

New Wilmington Produce Auction

3238 State Route 208
 New Wilmington, PA 16142
 724-946-8540

Vive Crop Protection

Unit 1, 6275 Northam Drive
 Mississauga, Ontario L4V 1Y8 Canada
 616-928-8720 (USA) ktaylor@vivecrop.com
 www.vivecrop.com

Weaverland Produce Auction

485 Quarry Rd., New Holland, PA 17557
 717-355-0834

Wes Stauffer Engine and Equipment *see ad on page 6*

23 Pleasant Valley Rd., Ephrata, PA 17522
 717-738-4215
 www.wesstauffer.com

Woodhouse Co. , J. S. *see ad on page 9*

572 Industrial Dr. Lewisberry PA 17339
 717-938-5100 fax – 717-938-8769
 www.jswoodhouse.com



The Pennsylvania Vegetable Growers Association holds the trademark for the "Pennsylvania Simply Sweet Onion", a premium brand of Pennsylvania-grown sweet onions. The Association licenses growers to grow certain varieties under specified conditions (plastic mulch with drip irrigation). Onions grown by licensed growers under these terms and which meet certain quality standards are allowed to be marketed as "Simply Sweets". For further information on how to grow "Simply Sweets"; contact PVGA at 717-694-3596 or pvga@pvga.org. You can also visit www.pennsylvaniasimplysweetonions.com

Which is Which? Are They the Same?



Pennsylvania Vegetable Growers Association

The Pennsylvania Vegetable Growers Association (PVGA) is the voluntary association of growers that publishes this newsletter, sponsors the Mid-Atlantic Fruit and Vegetable Convention, and provides other grower educational resources. It helps fund research with profits from its Farm Show food booth.

While both groups work together to fund practical vegetable research and promote the vegetable industry, they are completely separate organizations controlled by separate boards – PVGA by its elected Board of Directors and PVMRP by its Board of growers appointed by the state Secretary of Agriculture.

William Troxell serves as the staff person for both groups and they share the same phone number, but they are two separate groups.



PENNSYLVANIA VEGETABLE MARKETING & RESEARCH PROGRAM

The Pennsylvania Vegetable Marketing and Research Program (PVMRP) is the mandatory state check-off program for all growers with 1 acre of field or 1,000 sq. ft. of greenhouse/high tunnel production. It funds research and promotes PA vegetables.

Connections for Berry Growers

Online Info Exchange

PVGA sponsors a monthly get-together for berry growers on the second Monday night of the month at 8:00 p.m. The meetings are designed to give growers a chance to get time-sensitive updates on current issues from state and regional extension personnel, exchange info with other growers, get answers to their questions, or just listen in or bounce thoughts off of others. Kathy Demchak is the host. Calls are open to PVGA members and non-members so spread the word and invite your friends and neighbors to join.

The Zoom link is

<https://us02web.zoom.us/j/83077021881>

The call-in numbers are (be aware that this is not a toll-free call):

+1 929 436 2866 US (New York)

+1 301 715 8592 US (Washington DC).

The meeting ID is 830 7702 1881

If you have questions, contact us at pvga@pvga.org or 717-694-3596.

Berry Growers Facebook Group

This a forum for commercial berry growers to share production and marketing challenges and solutions among themselves. It is a private Facebook group open only to commercial berry growers, not to consumers. On Facebook, search for PVGA Berry Growers and ask to join the group.

Resources for Commercial Potato Growers

The PVGA Potato Committee has compiled the following list of online resources available to commercial potato growers at www.pvga.org.

Commercial Potato Production in North America (Potato Assn Of America)

Mid-Atlantic Commercial Potato Production Guide includes weed, insect, and disease controls plus recommendations on soil fertility and variety selection. Updated every two years by land grant university specialists.

Managing Seed Potatoes for Planting –

University of Maine – Bulletin #2412, Potato Facts: Selecting, Cutting and Handling Potato Seed – Cooperative Extension Publications – University of Maine Cooperative Extension (umaine.edu)

Penn State University Potato Research

Reports – includes annual reports on potato research at Penn State

Chip Potato Variety Trial Reports from PA – a link to Potatoes USA Potato Variety Database. Pennsylvania chip variety field trial results are included in this data base with tutorial videos to get you started.

Pennsylvania Vegetable Growers Association

2022 Membership Form



Name _____

Farm Name _____

Address _____

City/State _____ Zip Code _____

PA County _____ Telephone ____/____/____ Cell Phone ____/____/____

Facsimile ____/____/____ Electronic Mail _____

Business Information Please check all that apply.

Grower (owner-operator) Retail Wholesale
 Fresh Market Vegetables Processing Vegetables Greenhouse Vegetables Potatoes
 Small Fruit Bedding Plants Cut Flowers Tree Fruit Wine Grapes
 Grower Employee Supplier (equipment, chemicals, etc.) Processor Other _____

2022 PVGA Membership Dues

Regular Membership A \$5 discount is allowed for dues paid before February 5. \$75.00 _____

Open to all owner, operators and employees of vegetable, potato and berry farm operations, processing firms and supply companies. All memberships include newsletter subscription.

Associate Regular Membership Includes newsletter subscription. \$40.00 _____

Must be one of the following - circle one: Student Retired University Staff Extension Agt.

Keystone Membership An optional membership category open to vegetable and berry farming operations, processing firms, and supplier firms. Includes newsletter subscription. _____

Dues based on gross income from vegetable potato or berry industries. Any member paying \$75 or more in dues will be considered a Keystone Member. The following rates are only suggestions.

\$100 for up to \$75,000 \$125 for \$75,000 to \$150,000 \$175 for \$150,000 to \$225,000
 \$225 for \$225,000 to \$500,000 \$300 for \$500,000 to \$1,000,000 \$400 for over \$1,000,000

Associate Keystone Membership Must be a family member or employee of a Keystone Member. \$40.00 _____

2022 Mid-Atlantic Fruit and Vegetable Convention

Proceedings _____ @ \$20.00 _____

Country Folks Grower -Check here to receive a free monthly subscription to this publication _____

Total Enclosed

Payment by check or money order only - make checks payable to "PVGA" _____

Mail this registration form and payment to: **PVGA, 815 Middle Road, Richfield, PA 17086-9205** 717-694-3596 - phone and fax

Thank you for your membership in PVGA that brings you



- Subscriptions to the *American Vegetable Grower* magazine and the *Vegetable Growers News*

Besides making you part of the organization that:

- Sponsors the Mid-Atlantic Fruit and Vegetable Convention
- Also sponsors local grower meetings and tours
- Provides support for vegetable and small fruit research (over \$1.3 million in the last 33 years!)
- Is the voice of the Pennsylvania Vegetable, Potato and Berry industries

IMPORTANT TELEPHONE NUMBERS

Poison Control Center 800-222-1222

Agri-Service Agency – health and worker's compensation insurance for PVGA members 877-466-9089

Integrated Pest Management Hotline & Pesticide Update Credit Information 800-PENN-IPM

Penn State Cooperative Extension Offices

Adams	717-334-6271
Allegheny	412-263-1000
Armstrong	724-548-3447
Beaver	724-774-3003
Bedford	814-623-4800
Berks	610-378-1327
Blair	814-940-5989
Bradford	570-265-2896
Bucks	215-345-3283
Butler	724-287-4761
Cambria	814-472-7986
Cameron	814-486-3350
Carbon	570-325-2788
Centre	814-355-4897
Chester	610-696-3500
Clarion	814-223-9028
Clearfield	814-765-7878
Clinton	570-726-0022
Columbia	570-784-6660
Crawford	814-333-7460
Cumberland	717-240-6500
Dauphin	717-921-8803
Delaware	610-690-2655
Elk	814-776-5331
Erie	814-825-0900
Fayette	724-438-0111
Forest	814-755-3544
Franklin	717-263-9226
Fulton	717-485-4111
Greene	724-627-3745
Huntingdon	814-643-1660
Indiana	724-465-3880
Jefferson	814-849-7361
Juniata	717-436-7744
Lackawanna	570-963-6842
Lancaster	717-394-6851
Lawrence	724-654-8370
Lebanon	717-270-4391
Lehigh	610-391-9840
Luzerne	570-825-1701
Lycoming	570-433-3040
McKean	814-887-5613
Mercer	724-662-3141
Mifflin	717-248-9618
Monroe	570-421-6430
Montgomery	610-489-4315
Montour	570-784-6660
Northampton	610-813-6613
Northumberland	570-988-3950
Perry	717-582-5150
Philadelphia	215-471-2200
Pike	570-296-3400
Potter	814-274-8540
Schuylkill	570-622-4225
Snyder	570-556-4760
Somerset	814-445-8911
Sullivan	570-928-8941

Penn State Cooperative Extension Offices *(continued)*

Susquehanna	570-278-1158
Tioga	570-724-9120
Union	570-556-4760
Venango	814-437-7607
Warren	814-563-9388
Washington	724-228-6881
Wayne (extension 4110)	570-253-5970
Westmoreland	724-837-1402
Wyoming	570-836-3196
York	717-840-7408

Pennsylvania Department of Agriculture

Pesticide Regulations, Worker Protection Standards, Chemsweep Program, Plant Inspection, Food Safety Inspection - contact nearest regional office

Northwest - Meadville	814-332-6890
North Central - Montoursville	570-433-2640
Northeast- Tunkhannock	570-836-2181
Southwest – Greensburg	724-832-1073
Southwest Central - Martinsburg	814-793-1849
Southeast Central - Harrisburg	717-346-3223
Southeast - Creamery	610-489-1003
Seasonal Farm Labor	717-787-4315
Market Development	717-783-8462
PA Preferred Program	717-705-9511
Food Safety	717-787-4315
Plant Industry - Pesticides	717-787-4843
Fruit and Vegetable Inspection	717-787-4315
Farmers' Market Nutrition Program	717-772-2693
Ag Workforce Development	717-346-0426

Pennsylvania Department of Labor & Industry

General Information	717-787-5279
Workers' Compensation	800-482-2383
Right to Know	717-783-1826
Workforce Development	717-787-6521

Pennsylvania Vegetable Marketing and Research Program

717-694-3596

Pennsylvania Vegetable Growers Association

717-694-3596

***If you do not know who to call,
call PVGA at 717-694-3596
We can help find an answer.***



Pennsylvania Vegetable Growers Association

815 Middle Road
Richfield, Pennsylvania 17086-9205
717-694-3596
pvga@pvga.org
www.pvga.org

Change Service Requested

PRESORTED STANDARD
U.S. POSTAGE
PAID
HARRISBURG PA
PERMIT NO. 533



The path to Success isn't lined with pumpkins!

Cooperating and networking with fellow growers through PVGA membership is a good start down the right path.

*Serving Growers for 95 Years
1926 - 2021*

PVGA Membership includes a subscription to this monthly newsletter and our weekly PVGA Update email plus a voice in the Association that represents the Pennsylvania vegetable, potato and berry industries.

**See page 2 for more reasons YOU should join PVGA!
Use the form on page 30.**