

PENNSYLVANIA
VEGETABLE GROWERS

NEWS



Volume 47/Buyers' Guide

for the commercial vegetable, potato and berry grower



2024 Buyers' Guide





**Pennsylvania
Vegetable Growers
Association**

An association of
commercial vegetable,
potato and berry growers.

President

Peter Flynn '27
West Chester

First Vice President

Tina Forry '25
Palmyra

Second Vice President

Christopher Harner '26
State College

Secretary-Treasurer

William Reynolds '25
Waynesboro

Past President

Rita Resick '26
Somerset

Directors

Morgan Bond '27
Ringtown

Brian Campbell '27
Berwick

Barron Hetherington '25
Ringtown

Alan Kemmerer '25
Berwick

Arthur King '27
Valencia

Amy Metrick '24
Butler

James Reiff '26
Leola

John Shenk '26
Lititz

Robert Shenot '25
Wexford

Jeffrey Stoltzfus '26
Atglen

Jonathan Strite '25
Harrisburg

Mark Troyer '24
Waterford

Joel Weaver '26
Windber

Executive Director

Tammy K. Linn
Harrisburg

Dear Pennsylvania Grower

This special edition of the Pennsylvania Vegetable Growers News has been prepared as a source book of information for you, the Pennsylvania grower. You will find various vendors of equipment, supplies, and services who deal with Pennsylvania growers. Keep this resource handy to refer to throughout the year.

If you are not a current PVGA member, we invite you to consider joining. If you are a vegetable, potato or berry grower, you should belong to the organization that represents your industry. Founded in 1926, PVGA has been serving growers like you for the past 97 years. Your membership will strengthen the association's position as the official voice of the vegetable, potato, and berry industries and will also provide numerous benefits to you.

As a member, you will receive the Pennsylvania Vegetable Grower News, which will keep you informed on what is happening in the vegetable, potato, and berry industries, as well as our weekly email update (for those who provide a valid email address), and a discounted registration fee for the Mid-Atlantic Fruit and Vegetable Convention. PVGA members also receive free subscriptions to the *American Vegetable Grower* and the *Vegetable Growers News*.

Each year the Association co-sponsors the Mid-Atlantic Fruit and Vegetable Convention in Hershey. This year's Mid-Atlantic Convention was held January 30 – February 1 and was designed to continue the tradition of providing several days of concurrent educational sessions on processing vegetables, fresh market vegetables, potatoes, small fruits, direct marketing, organic vegetables, and urban agriculture. The Mid-Atlantic Convention has become one of the premier grower meetings in the northeast and beyond. PVGA also sponsors regional grower meetings and farm market tours.

Over the past 35 years, PVGA has given over \$1.35 million to research. This has been made possible from profits of the Association's food booth at the Pennsylvania Farm Show and from Convention profits. The food booth also helps to promote the vegetable and berry products you produce.

PVGA represents the interests of the vegetable, potato and berry industries on both state and federal issues. The Association contacts legislators regularly on issues that affect our growers. Special attention is given to food safety, state budget appropriations, labor, deer crop damage, irrigation (water use), high tunnels, and pesticides as they relate to horticultural growers.

If you are not currently a PVGA member, we urge you to support the association that represents your livelihood by joining today. Join your fellow growers in working together to benefit the entire grower community in providing educational events and resources, funding practical research, advocating for our industry and promoting our products. Our membership application can be found on our website at <https://www.pvga.org/joinpvगतoday/>

Pennsylvania Vegetable Growers News is the official publication of the
Pennsylvania Vegetable Growers Association

908 N 2nd St., Harrisburg, PA 17102 | 717-973-5915 | pvga@pvga.org | www.pvga.org

Our Mission:

PVGA serves Pennsylvania's commercial vegetable, potato and berry growers through education, research, advocacy and promotion.

Our Vision:

The Pennsylvania Vegetable Growers Association will be the driving force in ensuring the future viability of the commercial vegetable, potato and berry industries in Pennsylvania.

Inquiries about membership, this publication or advertising rates should be directed to PVGA at the above address.

Vendors By Category

Vendors are listed below by category of the equipment, supplies or services they offer. An alphabetical listing of vendors and their addresses begins on page 24.

General Equipment

Tillage and Cultivating Equipment

Hillside Cultivator – 717-626-6194
I & J Manufacturing - 717-442-9451
Market Farm Implement - 814-443-1931
Wes Stauffer Engine and Equipment – 717-738-4215

Bed Shaper Equipment

Market Farm Implement - 814-443-1931
Nolt's Produce Supplies – 717-656-9764, 661-7069

Fertilizer Application Equipment

Market Farm Implement – 814-443-1931
Mechanical Transplanter – 800-757-5268

Refrigerated and Ventilated Cooling Systems for Fruit and Vegetable Storages

- COMMERCIAL REFRIGERATION
- DESIGN, SALES AND SERVICE
- SERVING AGRICULTURE FOR OVER 70 YEARS

Free Consultation and Quote
Call Mike Mager at 585-343-2678



ARCTIC

REFRIGERATION CO. OF BATAVIA

26 Cedar Street, Batavia, NY 14020

www.arcticrefrigeration.com



Helping farmers and gardeners be successful for 78 years.

Feed Supplements for Cattle, Swine, Goats, Sheep, Horses, Chickens and more!

Free consulting!

Fertilizer Blends for your Farm & Garden

Our Mission
Your trusted partner, healing the earth and feeding the world - *Better Naturally!*

Nationwide Dealer Network



PRODUCER OF NATURAL & ORGANIC FEED SUPPLEMENTS & FERTILIZERS

Contact a local Fertrell Representative through our online locator or Download a catalog at www.fertrell.com. You may also call our main number 800-347-1566.

YOUR SOURCE FOR PRODUCE & VEGETABLE SPRAYERS

High Clearance Booms to go over Sweet Corn while High Pressure Pumps penetrate the canopy of any produce crop with up to 300 PSI



F750 70' AirRide Boom



F300 25' Single Boom



HT200 3pt 25' Single Boom

GREENHOUSE AND HIGH TUNNEL SPRAYERS

These sprayers are designed for spraying staked crops such as tomatoes and peppers. The high clearance offset axle straddles the row for minimal clearance and crop disturbance.



SEE US AT THE MID-ATLANTIC
FRUIT AND VEGETABLE CONVENTION
Jan 31-Feb 1 **BOOTH 13-14**



BCS Sprayer for Staked Produce



SP50 Self-propelled Sprayer



More Info & Videos

ivamfg.com

Call us to discuss your sprayer needs. Our team can help you to get the right sprayer for your needs!

3pt and Trailer Field Sprayers



BUILDING AG SPRAYERS
FOR 30 YEARS



F1000 45-75' AirRide Booms



F750 45-75' AirRide Booms



F500 35-45' SpringRide Booms



HT200 30-40' Manual Booms

(717) 768-0747 | 175 Churchtown Rd, Narvon Pa 17555 | ivamfg.com

Find us on 

ROBERT MARVEL PLASTIC MULCH, LLC

Your source for all your plastic mulch
and drip irrigation needs since 1974!

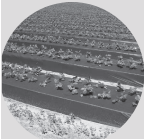

Mulch:

Biodegradable, Embossed, Smooth,
Photo degradable, **and more.**



Products:

Drip Irrigation Tape, Floating Row
covers, Greenhouse Plastic, Black
Woven Ground Cover, **and more.**



Equipment:

Raised Bed Mulch Layer, Flat Bed
Mulch Layer, Water Wheel
Transplanter, **and more.**

Download our 2024 Product Catalog and view
full descriptions of our products and more
online @ www.robertmarvel.com



Contact Us!



2425 Horseshoe Pike,
Anville, PA 17003



717-838-0976



Info@robertmarvel.com



www.robertmarvel.com

MECHANICAL TRANSPLANTER COMPANY

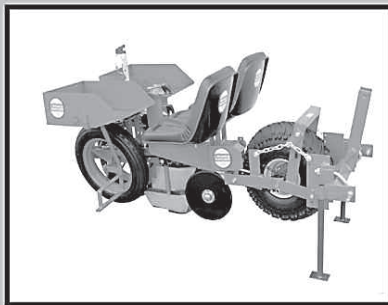

Model 1000

* Excellent for
bare root
and small
cells. Our
most popular
transplanter.

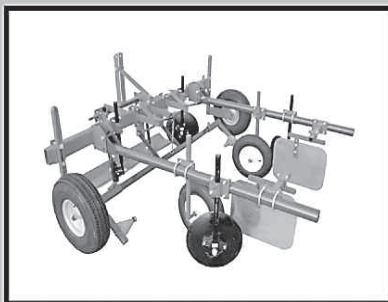

Model 90

* Lays any
size mulch
from 3-6
feet wide.

NEW CLEAN SEEDER



MODEL JP-1

* Excellent for
small seed
* Lightweight &
easy to handle
* Accurate
spacing

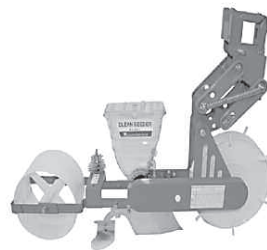

MODEL JPH

* Row spacing
as close as 7"
* Mounts on 2"
square toolbar

Mechanical Transplanter Company, LLC * 1150 Central Avenue * Holland, MI 49423

Phone: 616-396-8738 or 800-757-5268 * Fax: 616-396-3619

website: www.mechanicaltransplanter.com * e-mail: mtc@mechanicaltransplanter.com

General Equipment

Planting Equipment

- I & J Manufacturing – 717-442-9451
- Market Farm Implement – 814-443-1931
- Martin's Produce Supplies – 888-381-8641
- Mechanical Transplanter Co. – 800-757-5268
- Nolt's Produce Supplies - 717-656-9764, 661-7069
- Robert Marvel Plastic Mulch – 717-838-0976
- Stand'N Plant – 724-639-3965

Plasticulture Equipment

- Iva Mfg – 717-768-0740
- Martin's Produce Supplies – 888-381-8641
- Market Farm Implement – 814-443-1931
- Mechanical Transplanter Co. – 800-757-5268
- Nolt's Produce Supplies - 717-656-9764, 661-7069
- Robert Marvel Plastic Mulch – 717-838-0976
- Saylor's Farm Products – 814-745-2306

Harvesting Equipment

- Harvest Pro Manufacturing – 717-768-7619
- I & J Manufacturing – 717-442-9451
- Market Farm Implement – 814-443-1931
- Martin's Produce Supplies – 888-381-8641
- Nolt's Produce Supplies - 717-656-9764, 661-7069

Your Source for . . .

HIGH TUNNELS



Greenhouse Systems

Call Harry Edwards @ 717.606.8021
or Email hedwards@rimol.com

Two Locations to Serve You Better!



Nolt's Greenhouse Supplies

Specializing in Greenhouse and Nursery Growing Supplies

(717) 354-8376

151 E. Farmersville Road
Ephrata, PA 17522



Nolt's Produce Supplies, LLC

Specializing in Vegetable Growing Supplies and Equipment

(717) 656-9764

152 N. Hershey Avenue
Leola, PA 17540



Compact Raised Bed Mulch Layer



Greenhouses & High Tunnels



Hyd Reset Mulch Lifter



Hyd Drive Wrapper



Water Wheel Transplanter

Please contact us for our free commercial growers catalogs or view it on our website: www.noltsproducesupplies.net

Plant, Maintain And Harvest Your Produce

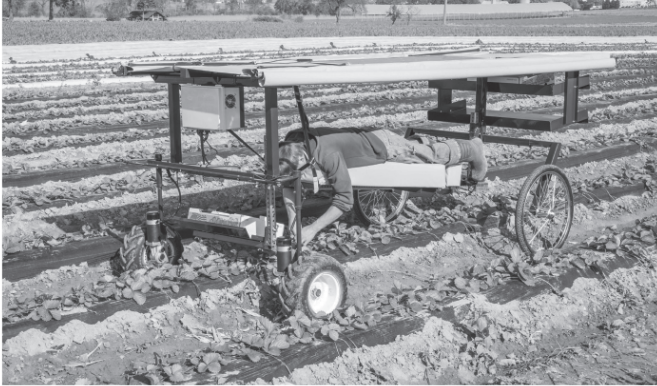

- Fully adjustable operator platform and head support for all day comfort
- Foot- Controlled Variable Speed and steering keeps both hands free for higher production



- : Trailer or wagon style option
- : 30 ft aluminum conveyor with paddles 12in apart
- : Conveyor can be moved from front to back with track system
- : Conveyor can be lifted above bins for transporting

Give us a call or visit our website for more information

25 Old Leacock Rd - Ronks Pa 17572
717-768-7619 | www.harvestpromfg.com

Since 2001 Authority in Refrigeration for Agro-Industrial Applications in North America.

PLUG AND PLAY



FREE COOLING

- Thru the Wall
- Portable
- Roof Mounted
- Hydrocoolers
- Custom Designs
- Blast Freezers
- Chillers
- Greenhouse Coolers

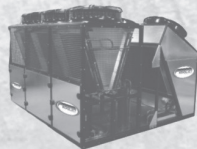

1.866.748.7786
 info@kooljet.com

NOURSE

Delivering Quality

NourseFarms.com | 413-665-2658 | info@noursefarms.com

WE DELIVER
 high-quality plants
 so you can deliver a
high-quality HARVEST.



SCAN TO VIEW

General Equipment

Grading and Packing Equipment

Market Farm Implement – 814-443-1931
Martin's Produce Supplies – 888-381-8641
Nolt's Produce Supplies - 717-656-9764, 661-7069
Tew Manufacturing Corp. – 800-380-5839

Refrigeration and Storage Systems

Arctic Refrigeration – 585-343-2678
KoolJet Refrigeration – 866-748-7786



TEW MANUFACTURING CORP.

**Fruit & Vegetable Cleaning &
Sizing Equipment & Parts**

**Quality Latex & Poly Sponge
Rubber Drying Donuts**

Tuff Foam® Protective Padding

Brushes • Bearings • Sizing Chains

Belting • Scrubber Rubber

New Stainless Steel Machines

CALL TOLL FREE 800-380-5839
FOR CATALOG & PRICES

TEW MFG. CORP.

P.O. BOX 87

PENFIELD, NY 14526

585-586-6120

FAX: 585-586-6083

www.tewmfg.com



General Equipment

Irrigation Equipment and Supplies

- Flickinger's Nursery -724-397-4953
- Gristmill Farm – 717-354-8443
- Harris Seeds - 585-754-5245
- Market Farm Implement – 814-443-1931
- Martin's Produce Supplies – 888-381-8641
- Nolt's Produce Supplies - 717-656-9764, 661-7069
- Robert Marvel Plastic Mulch – 717-838-0976

Pesticide Application Equipment

- Iva Mfg – 717-768-1747
- Market Farm Implement – 814-443-1931
- Martin's Produce Supplies – 888-381-8641
- Martin's Repair Shop - 717-733-3015
- Penns Creek Welding - 570-837-1197



~ Quality Seed Since 1881 ~

Stokes Seeds Pennsylvania Seed Consultants

ASK US ABOUT OUR FULL LINE OF COMMERCIAL VEGETABLE SEED!

Contact **Tom Pagels** and **Steve Stout** for the highest quality seed and service.

609-703-5082
sstout@stokeseeds.com

609-247-7140
tpagels@stokeseeds.com



T: 1-800-962-4999 | www.stokeseeds.com | 13031 Reflections Dr Holland MI 49424

General Supplies

Mulching/Row Covers

- Gristmill Farm – 717-354-8443
- Harris Seeds - 585-754-5245
- Martin's Produce Supplies – 888-381-8641
- Mechanical Transplanter Co. – 800-757-5268
- Nolt's Produce Supplies - 717-656-9764, 661-7069
- Robert Marvel Plastic Mulch. – 717-838-0976

Fertilizer

- Daniel's Farm Store LLC - 717-656-6982
- Fertrell Company - 717-367-1566
- Gristmill Farm – 717-354-8443
- Keystone Bio-Ag – 717-354-2115
- Martin's Produce Supplies – 888-381-8641
- Miller Chemical and Fertilizer LLC – 208-599-8665
- Nolt's Produce Supplies - 717-656-9764, 661-7069
- Redox Bio-Nutrients – 208-678-2610

Greenhouse Supplies

- Greenhouses & Supplies
- Heaters & Fans
- Fertilizers
- Irrigation
- Sprayers
- Produce Supplies

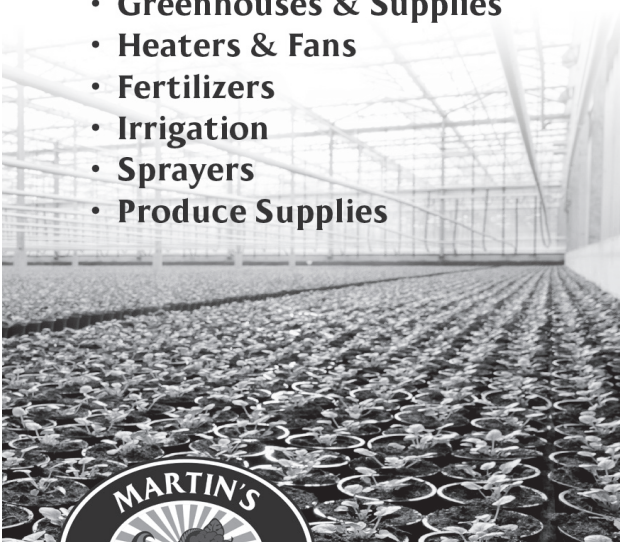

717-532-5918

888-381-8641

MartinsProduceSupplies.com



MAXIMIZE YOUR YIELD & QUALITY

We are dedicated to growing stronger plants more efficiently through improved plant performance. Our technology helps growers build a strong foundation in the four pillars of bio-nutrition:

Sh
Soil Health

Rd
Root Development

Ne
Nutrient Efficiency

AsD
Abiotic Stress Defense



Soil Health:

Necessary to support optimum soil biology and plant growth.



Nutrient Efficiency:

Increasing soluble carbon to improve nutrient availability for root growth and microbial diversity.



Root Development:

Essential to healthy plants and maximizing performance potential.



Abiotic Stress Defense:

Critical protection against stress factors that can reduce performance.

Contact your local Redox Bio-Nutrients Agronomist:



SAM EVANS

sam.evans@redoxgrows.com

(814) 207-9489

LISTEN TO OUR REDOX GROWS PODCAST

redoxgrows.com

@redoxgrows

Contact us for more information at (208) 678-2610



Scan the QR code to listen to our Podcast

General Supplies

Pesticides/Plant Growth Regulators

Certis Biologicals – 800-250-5024
Daniel's Farm Store LLC - 717-656-6982
Fertrell Company – 717-367-1566
Gowan Co - 845-745-9246
Martin's Produce Supplies – 888-381-8641
ProFarm Group - 717-877-7105

Biocontrols – Beneficial Insects

Certis Biologicals – 800-250-5024
IPM - 315-497-2063
ProFarm Group - 717-877-7105

VEGETABLE FARM EQUIPMENT
AUCTION SPECIALISTS
PIRRUNG AUCTIONEERS, INC.
JAMES P. PIRRUNG
www.pirrunginc.com
585-728-2520

*"Serving the Buying - Selling Needs of Farmers
Across America Since 1948"*





RUPP FEATURE:

Ugly Dumpling is a 100-day, sweet dumpling. Partners claim it is the best tasting winter squash. Harvest a surprise



VIRTUE

This watermelon likes there to be a chill in the air.

Virtue has shown strong early season performance while keeping good yields and taste.



DIAMOND MINE

Diamond Mine is one of the best tasting whites available.

A 76-day sweet corn that produces large ears with excellent tip fill and husk cover.



GOLDEN RAY

Both unique and attractive. It's a fresh market winner!

Golden Ray is a sunflower with the ability to draw new customers to your fresh market.

The best products from the top producers including:
Sygenta, Crookham, and Genesis Seeds.

More than 1,000 seed varieties at ruppseeds.com

Questions/Orders: 1-800-700-1199



RAISING THE BAR

IN QUALITY, FLAVOR, & YIELD

General Supplies

Containers and Packaging Supplies

- Harris Seeds - 585-754-5245
- Martin's Produce Supplies - 888-381-8641
- Nolt's Produce Supplies - 717-656-9764, 661-7069
- ProducePackaging.com - 800-644-8729
- Saylor's Farm Products - 814-745-2306
- Statewide Bag Service - 717-647-2623
- Southern Container Corp. - 232-230-4958



ProducePackaging.com[®]
for all your produce packaging needs

1-800-644-8729
 Kurt Zuhlke & Assoc., Inc.
 P.O. Box 609, Bangor, PA 18013



Over 45 Years In The Industry

For over 45 years, Kurt Zuhlke & Assoc., Inc. has been a part of the many innovative packaging concepts utilized by the produce industry.

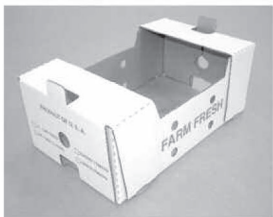

High Quality Products And Services

Our packaging is designed to protect produce, provide excellent visibility to the consumer, reduce shrinkage and enhance the product. We also offer professional labeling design and application.

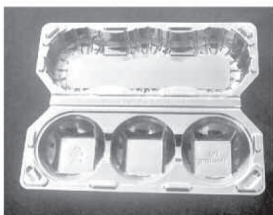

From Farmers To Repackers

Whether you are ordering a case or a truck load, you can rest assured that we have the ability and capacity to service your orders quickly.





PLANT. PICK. PROFIT.

BETTER GENETICS. BETTER PRODUCTIVITY.
BETTER PROFITABILITY.

EXCLUSIVE



LUNAR

56 Day Fresh Market Bush Bean

This SEEDWAY EXCLUSIVE has strong seed quality. Excellent plant habit for easier harvest. Does well in hot growing conditions. Uniform, dark green pods (3-4 sieve).

HR: BCMV, CI
IR: Ua

EXCLUSIVE



AUTUMN PEARL

95 Day Pie Pumpkin

Pie pumpkins are a favorite everywhere! Autumn Pearl makes its introduction into the pie pumpkin class with an all around eye catching appearance: sturdy handle, distinct ribbing and dark orange color. One to try for 100-110 count bins (24" bins). Recommended spacing is 15 to 18 square feet per plant. IR: Sf

EXCLUSIVE



BEACON

70 Day Sweet Banana Pepper

This sweet banana pepper combines excellent disease resistance with great early yield of straight, heavy, thick walled fruit. It is great for processing. HR: Xcv 1 - 3, TSWV

EXCLUSIVE



LAZOR

42 Day Yellow Straightneck Summer Squash

Exceptionally firm, smooth fruit alleviates some of the "roughness" typical of first picks. Thick and sturdy neck promotes easy handling. Attractive glossy skin.

IR: ZYMV

(800) 952-7333

www.seedway.com

MRS AIR BLAST SPRAYER

5 X 5 Spray Head
Sprays 12-15 Ft.
on both sides

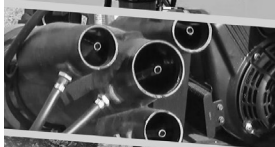

- > 23 HP Vanguard engine
- > Electric start
- > 60 gallon tank
- > Trailer hook up
- > Electric diaphragm pump

PRODUCED BY



27 W Mohler Church Rd. Ste
1 Ephrata, PA 17522
717-733-3015

lambert

PREMIUM PROFESSIONAL PEAT-BASED SUBSTRATES



FOR ALL YOUR GERMINATION AND ALL PURPOSE NEEDS



DENNIS DOBROWSKI
Cell: (484) 716-5662
Toll Free: (888) 632-8808
lambertpeatmoss@aol.com
www.lambertpeatmoss.com



Paper & Poly Potato Bags
Mesh Bags for Onions, Cabbage & Sweet Corn
Fischbein Sales & Service
Thread & Wire Ties



Large inventory of Produce Packaging
2lb. to 50 lb. Paper Potato Bags
Paper Master Containers
Poly Potato Bags
3 lb. 10 lb. 25lb. & 50 lb. Mesh Onion Bags
Mesh Cabbage & Mesh Sweet Corn Bags
Wire Ties & Kwik Loks
Fischbein Portable Bag Closers
Fischbein Parts & Repairs done on site
Thread / 8 oz. to 20 lb. Cones
CALL

717-647-2623 -717-460-7962

Visit our website at

www.tallmanpotatoes.com

see our full line of products
**CALL STATEWIDE BAG SERVICE
FOR YOUR
PRODUCE PACKAGING NEEDS
HIGH QUALITY PRODUCTS
& PERSONALIZED SERVICE**
sjtallman@tallmanpotatoes.com

RAIN-FLO IRRIGATION



*Serving your irrigation needs...
Call today for your free catalog.*

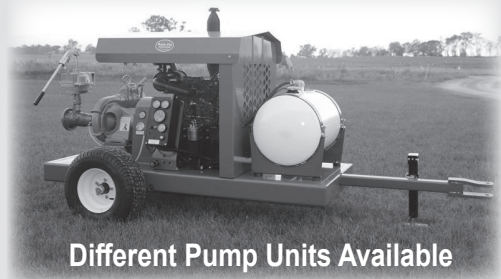

**Mfg. of Vegetable Machinery
Sales of Drip Irrigation & Plastic Mulch
Retail ▪ Wholesale**

**929 Reading Rd
East Earl, PA 17519
(717)445-3000
www.rainfloirrigation.com**

Vegetable Supplies

Vegetable Seeds

- Harris Seeds - 585-754-5245
- Martin's Produce Supplies - 888-381-8641
- Nolt's Produce Supplies - 717-656-9764
- Outstanding Seed Co. - 800-385-9254
- Rupp Seeds - 419-337-1841
- SeedWay - 800-952-7333
- Stokes Seeds - 800-263-7233

Vegetable Plants



- Harris Seeds - 585-754-5245
- Re-Divined - 717-875-6644

Small Fruit Supplies

Berry Nurseries

- Nourse Farms, Inc. - 413-665-2658

STAND 'N PLANT

<h2>SEEDER</h2> <p>Use for...</p> <ul style="list-style-type: none">• Seeds• Onions• Garlic 	<p><i>Easily plant hundreds of seeds or plants per hour into plastic covered or bare ground seed beds.</i></p>	<h2>PLANTER</h2> <p>Use for...</p> <ul style="list-style-type: none">• Transplants• Potatoes• Bulbs 
--	--	---

Stand 'N Plant
95 Rose Road, Saltsburg, PA 15681
Phone: 724-639-3965 or visit: www.standnplant.com



Photo - Kathleen Demchak

Produce Growing Supplies
Early Order Discounts
Starting Dec. 11th 2023
Through Jan. 12th 2024

Stocking irrigation supplies in
 1/2", 3/4", 1", 1 1/2", 2", and 3".



lambert
 At the root of your success since 1928



Titan FRP
 Tomato Stakes

Heavy Duty
 1" round x72"

Call for free catalog.
 Too many items to list



sungro
 HORTICULTURE
 Our Expertise is Growing[®]

BLACK GOLD[®]

PLASTIC MULCH
 Black
 Clear
 Black/White
 Metalized
 Also
 BIODEGRADABLE



NEW Fertilizer

TECHNIGRO[®]
 Water-Soluble Fertilizers

AgroThrive[®]
 ORGANIC BIO-FERTILIZERS

Gristmill Farm

201 Gristmill Rd.
 New Holland PA 17557
 Ph. 717-354-8443



Greenhouse & high tunnel
 plastic cut to the length you need!!
 10' to 54' widths in stock.



Clear - IR - 6mil - 4 mil - Blk/Wht - 70%White & Diffused High Tunnel Films

SEE VIDEOS OF SPRAYERS IN ACTION ON UPDATED WEBSITE!
NEW HYDRAULIC FOLD SPRAYER FEATURES
AIRBAG BOOM SUSPENSION!



200, 300 & 400 Gal. Manual Fold • 300 & 400 Gal. Hyd. Fold

Ask us about the advantages of the front mount boom.

PENNS CREEK MFG.

1340 Broadway Rd., Winfield, PA 17889

570-837-1197

www.pennscreekwelding.com

BUILDERS OF DEPENDABLE ECONOMICAL VEGETABLE SPRAYERS

Greenhouse Supplies and Equipment

Greenhouse Equipment and Supplies

- Daniel's Farm Store LLC – 717-656-6982
- Fertrell Company – 717-367-1566
- Gristmill Farms – 717-354-8443
- Harris Seeds - 585-754-5245
- IPM - 315-497-2063
- Iva Mfg – 717-768-0747
- Lambert Peat Moss – 888-632-8808
- Martin's Produce Supplies – 888-381-8641
- Martin's Repair Shop - 717-733-3015
- Nolt's Greenhouse Supplies - 717-354-8376
- Rimol Greenhouse Systems – 603-494-5775
- Robert Marvel Plastic Mulch – 717-838-0976

Bedding Plant Seeds/Plugs/Cuttings

- Harris Moran Seeds – 209-579-7333
- Harris Seeds - 585-754-5245
- Stokes Seeds – 800-263-7233

Greenhouse and Low/High Tunnel Structures

- Nolt's Greenhouse Supplies - 717-354-8376
- Rimol Greenhouse Systems – 603-494-5775

Growing Media

- Gristmill Farms – 717-354-8444
- Lambert Peat Moss – 888-632-8808
- Martin's Produce Supplies – 888-381-8641
- Nolt's Greenhouse Supplies - 717-354-8376



Hillside Cultivator Co. LLC



Hydraulic adjusted cultivator
for the edges of plastic mulch



Cultivators especially for
Strawberries



Eco Weeder for close cultivation
around individual plants

For more information visit hillsidecultivator.com

Contact: John Shenk 717-669-3158 Lititz, PA hillsidecultivator@gmail.com



Are you struggling with Disease and Quality challenges? We can help!

Soil & Crop Consulting

Balancing soil and plant nutrition for healthier and higher yielding crops.

Also Offering:

- Soil testing
- Plant Sap testing
- Dry Fertilizer
- Liquid Fertilizers
- Soluble Fertilizers
- Biological Inoculants
- Educational Content
- And more.....

We believe that nature has the most effective answers to the current farming challenges.



717-354-2115

www.keystonebioag.com

Direct Marketing Supplies

Farm Market Packaging

Harris Seeds – 585-754-5245

Statewide Bag Service – 717-647-2623



Supplies

Daniel's Farm Store LLC

Produce Chemicals and Biologicals

Check out our selection of Conventional and Organic/Biopesticides. Also stocking Pesticides for Greenhouse Produce Production. We are a Distributor for Non-Import Beneficial Insects – the New Tool for Insect Pest Resistance.

Call for Pricing – 717-656-6982

Equipment

Flickinger's Nursery

For Sale - Irrigation pipes, sprinklers, valves, couplers, end plugs at super cheap prices. Like new condition, stored inside in winter. Tom Flickinger, PO Box 245, Sagamore, PA 16250. 724-397-4953

For Sale - Used MRS Air Blast orchard sprayer. Use 1 year since new engine and new pump was installed. \$6000 or best offer. Call Roy Stoltzfus 717-675-4537

Employment

Position Available - Hollabaugh Bros., Inc. in Biglerville, PA is looking for an Assistant Business Manager for Production. Joining the Hollabaugh family is guaranteed to be rewarding if working with the land and growing food is the name of your game. Growing on 500 acres, the family operates a diversified fruit and vegetable growing enterprise that is driven by its ever-growing retail and wholesale entities. We are looking for someone to help manage the vegetable production on our farm, as well as provide support to irrigation, fruit production, orchard plantings, and more. Prior working knowledge of vegetable production and management is necessary.

Questions? Contact Ellie, ellie@hollabaughbros.com, 717-677-8412 ext. 124. Hollabaugh Bros., Inc.



Saylor's Farm Products

*We Also Make Watercaps
For Earlier Tomatoes*

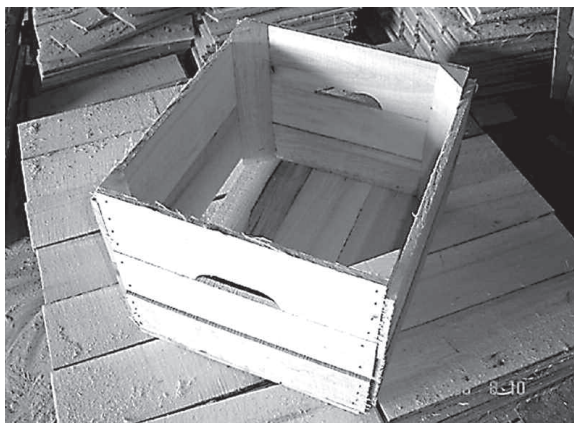

Manufacturers of Agricultural Containers.

www.saylorfarm.com



Saylor's Farm Products

17319 Route 68, Sligo, PA 16255

Phone 814-745-2306

john@saylorfarm.com

Growers Classified Ads

PVGA offers a classified service to vegetable, potato, and berry growers. Classified ads for used equipment or surplus supplies will be published at no cost in a Growers Classified section.

The ads will be published on the PVGA website at pvga.org/classified, included in the email update, and in the printed newsletter

Ads will be restricted to equipment or supplies specific to vegetable, potato, and berry production, not general farm equipment. Other such free classified sections are available in publications like Lancaster Farming, but this is designed to focus specifically on items of interest to our growers. Businesses that commercially sell equipment or supplies will not be able to advertise for free.

There are several ways to place an ad

- Email to pvga@pvga.org
- Mail to PVGA | 908 N 2nd St, Harrisburg, PA 17102
- Fax to 717-236-2046

Services

Associations

Pennsylvania Association for Sustainable Agriculture – 814-349-9856

Auctioneers

Pirring Auctioneers – 585-728-2520

Crop Insurance

Morrissey, Bernard, Insurance – 800-422-8335

Farm Succession and Land Access

PA Farm Link - 717-705-2121

Financial Services

Horizon Farm Credit – 888-339-3334

General Insurance (Liability, Workers Compensation, Health, Fire, etc.)

Morrissey, Bernard, Insurance – 800-422-8335

Government

Pennsylvania Department of Agriculture – 717-705-9511

Management Services/Products

Martin's Produce Supplies – 888-381-8641
PA Farm Link – 717-705-2121

Produce Auctions

Buffalo Valley Produce Auction – 570-966-1151
Countryside Produce Auction – 814-662-2222
Cumberland Valley Produce Auction – 717-530-5007
Juniata Wholesale Produce Sales LLC – 717-463-2484
Kutztown Produce Auction – 610-683-7161
Lebanon Produce Auction – 717-367-8379
Leola Produce Auction – 717-656-9592
Morrison's Cove Produce Auction – 814-793-9384
New Wilmington Produce Auction – 724-946-8540
Oxford Produce Auction – 610-392-2722
Shippensburg Produce Auction - 717-532-5511
Smicksburg Produce Auction – 814-221-5103, 229-0056
Snyder County Produce Auction – 570-374-0284
Sugar Valley Produce Auction – 570-725-2000
Sunnyburn Produce Auction – 717-862-3010
Weaverland Produce Auction – 717-355-0834



BCS

THE BEST TILLER ON EARTH
No Belts • No Chains • No Equal



PRE SEASON SALE

- 18" To 30" Tillers
- Models 7 To 13HP
- Quick Change Handle Positions
- No Time-Limit Warranty on Transmissions
- 50% Higher Tine Speed Than Competition
- Free Quick Hitch w/2+ Attachments On 732 to 853



Rotary Plow



Power Harrow



Brush Mowers



Sickle Bar Mowers



Snow Throwers

Also: Flail Mowers • Chipper/Shredder • Wood Splitter • Utility Trailer

WES STAUFFER EQUIPMENT LLC
www.wesstauffer.com 717-738-4215
BCS Dealer For 38 Years!
23 Pleasant Valley Rd., East of Ephrata off Rt. 322 - Mon., Wed. & Thurs., 8-5:30; Tues. & Fri., 8-7; Sat., 8-1

Vendors by Name

Arctic Refrigeration Co. (see ad on page 3)
26 Cedar St. | Batavia, NY 14020
585-343-2678
www.arcticrefrigeration.com

Buffalo Valley Produce Auction
Violet Road | Mifflinburg, PA 17844
570-966-1151 | fax 570-966-2601
www.buffalovalleyproduce.com/

Certis Biological
9145 Guilford Rd., Ste 175 | Columbia, MD 21046
800-250-5024
www.CertisUSA.com

Countryside Produce Auction
1695 Savage Rd. | Salisbury, PA 15558
814-662-2222

Cumberland Valley Produce Auction
101 Springfield Rd. | Shippensburg, PA 17257
717-530-5007
cvproduceauction.com

Daniel's Farm Store LLC (see ad on page 22)
324 Glenbrook Rd. | Leola, PA 17540
717-656-6982

Fertrell Company (see ad on page 3)
PO Box 265 | Bainbridge PA 17502-0265
717-367-1566
www.fertrell.com

Flickinger's Nursey (see ad on page 22)
PO Box 245 | Sagamore, PA 16250
724-397-4953

Gardner Pie Co.
191 Logan Pkwy | Akron, OH 44319
330-245-2030
www.gardnerpie.com

Gowan Co
845-745-9246
www.gowanco.com

Gristmill Vegetable Farm (see ad on page 19)
201 Gristmill Rd | New Holland PA 17557
717-354-8444 | fax - 717-354-8444

Harris Seeds
355 Paul Road | Rochester, NY 14624
800-544-7938 | 877-892-9197-fax
www.harriseseeds.com

Harris Moran Seed Co.
555 Codoni Avenue | Modesto, CA 95357
209-579-7333 | 209-544-0335-fax
www.harrismoran.com

Harvest Pro Manufacturing (see ad on page 7)
25 Old Leacock Rd. | Ronks, PA 17572
717-768-7619
www.harvestpromfg.com

Hillside Cultivator (see ad on page 20)
911 Disston View Dr. | Lititz, PA 17543
717-626-6194
www.hillsidecultivator.com

Horizon Farm Credit
300 Winding Creek Blvd. | Mechanicsburg, PA 17050
888-339-3334
www.HorizonFC.com

I & J Manufacturing
10 S. New Holland Rd., Suite 2 | Gordonville, PA 17529
717-442-9451
www.farmingwithhorses.com

IPM Laboratories
PO Box 300 | Locke, NY 13092-0300
315-497-2063 | 315-497-3129 - fax
www.ipmlabs.com

Iva Mfg. (see ad on page 4)
175 Churchtown Rd | Narvon, PA 17555
717-768-0747
www.ivamfg.com

Keystone Bio-Ag (see ad on page 21)
430 Voganville Road | New Holland, PA 17557
717-354-2115
www.keystonebioag.com

King's Agri-Seeds
1828 Freedom Rd | Lancaster, PA 17601
717-687-6224
www.kingsagriseeds.com

KoolJet Refrigeration (see ad on page 7)
150 Adams Blvd. | Brantford, ON N3S 7V2
866-748-7786 | 519-452-4040-fax
www.kooljet.com

Kutztown Produce Auction
209 Oakhaven Rd. | Fleetwood, PA 19522
610-683-7161 | 610-683-5429-fax
www.kutztownproduceauction.com

Lambert Peat Moss (see ad on page 16)
106 Lambert Rd. | Riviere-Ouelle, QU Canada G0L 2C0
888-632-8808 | 484-716-5662
www.lambertpeatmoss.com

Lebanon Produce Auction
166 W. Reistville Rd. | Myerstown, PA 17067
717-949-2643
www.lebanonproduceauction.com

Leola Produce Auction
135 Brethren Church Rd. | Leola, PA 17540
717-656-9592
www.leolaproduceauction.com

Market Farm Implement
257 Fawn Hollow Rd. | Friedens, PA 15541
814-443-1931
www.MarketFarm.com

Vendors By Name

Martin's Produce Supplies (see ad on page 10)

627 Britton Rd. | Shippensburg, PA 17257
888-381-8641 | 717-532-5872-fax
www.martinsproducesupplies.com

Martin's Repair Shop (see ad on page 16)

28 E. Trout Run Rd. | Ephrata, PA 17522
717-733-3015 | fax – 717-733-9618-fax

Mechanical Transplanter Co. (see ad on page 5)

1150 Central Ave. | Holland, MI 49423-5230
800-757-5268 | fax – 616-396-3619
www.mechanicaltransplanter.com

Miller Chemical and Fertilizer, LLC

3100 Cumberland Blvd., Suite 600 | Atlanta, GA 30339
208-599-8665
www.millerchemical.com

Morrison's Cove Produce Auction

174 Windy Acres Ln. | Roaring Springs, PA 16673
814-793-9384

Morrissey Insurance Inc. , Bernard

890 N. Reading Rd. | Ephrata, PA 17522
800-422-8335 | 717-336-3729-fax
www.insuringyourfuture.com

Nolt's Produce Supplies (see ad on pages 6)

152 North Hershey Ave. | Leola, PA 17540
717-656-9764
www.noltsproducesupplies.net

Nourse Farms, Inc. (see ad on page 7)

41 River Rd. | South Deerfield, MA 01373
413-665-2658 | 413-665-7888-fax
www.noursefarms.com

Outstanding Seed Co. LLC (see ad on page 28)

PO Box 1584 | Beaver Falls, PA 15010
800-385-9254
www.outstandingseed.com

Oxford Produce Auction

200 Union School Rd. | Oxford, PA 19363
610-392-2722

PA Farm Link

2301 N. Cameron St. | Harrisburg, PA 17110
717-705-2121
www.pafarmlink.org

PA Farm Markets, LLC

4184 Dorney Park Rd, Room 104 | Allentown, PA 18104
610-391-9840
www.pafarm.com

PA Preferred Program

2301 N Cameron St. | Harrisburg, PA 17110-9408
717-705-9511
www.papreferred.com

Pasa Sustainable Agriculture

1631 N. Front St. | Harrisburg, PA 17102
814-349-9856
www.psafarming.org

Penns Creek Welding & Manufacturing (see ad on page 19)

1340 Broadway Road | Winfield, PA 17889
570-837-1197
www.pennscreekwelding.com

Pennsylvania Department of Agriculture

2301 N Cameron St. | Harrisburg, PA 17110-9408
717-409-0219
agriculture.pa.gov/agbiz

Pennsylvania Vegetable Marketing and Research Program

2301 N. Cameron St. | Harrisburg, PA 17110
717-694-3596
www.paveggies.org

Pirrung Auctioneers, Inc. (see ad on page 12)

PO Box 607 | 2731 East Naple Street | Wayland, NY 14572
585-728-2520 | 585-728-3378-fax
www.pirrunginc.com

ProducePackaging.com (see ad on page 14)

PO Box 609 | 20 Market St. | Bangor, PA 18013
800-644-8729
www.producepackaging.com

ProFarm Group

1540 Drew Ave. | Davis, CA 95618
717-877-7105
www.marronebio.com

Rain-Flo Irrigation (see ad on page 17)

929 Reading Rd | East Earl, PA 17519
717-445-3000
www.rainfloirrigation.com

Re-Divined

142 Black Swamp Rd | Bainbridge, PA 17502
717-286-7658
www.redivined.weebly.com

Redox Bio-Nutrients (see ad on page 11)

130 South 100 West | Burley, ID 83318
208-678-2610 | 208-677-3609 -fax
www.redoxgrows.com

Rimol Greenhouse Systems (see ad on page 6)

40 London Derry Tpk. | Hooksett, NH 03106
717-606-8021 | 603-629-9023-fax
www.rimol.com

Robert Marvel Plastic Mulch-Irrigation (see ad on page 5)

2425 Horseshoe Pike | Annville, PA 17003
717-717-838-0976 | fax – 717-838-0978
www.RobertMarvel.com

Rupp's Seeds (see ad on page 13)

17919 Road B | Wauseon, OH 43567
800-700-1199
www.ruppseeds.com

Saylor's Farm Products (see ad on page 22)

17319 Rt 68 | Sligo, PA 16255
814-745-2306
www.saylorsfarm.com

Vendors By Name

Seedway (see ad on page 15)

99 Industrial Rd | Elizabethtown, PA 17022
800-952-7333 | fax – 800-645-2574
www.seedway.com

Shippensburg Produce Auction

1120 Ritner Hwy. | Shippensburg, PA 17257
800-346-2334
sauctioncenter.com

Smicksburg Produce Auction

1526 Barnard Rd. | Smicksburg, PA 16256
814-221-5103 or 814-229-0056

Snyder County Produce Auction

6130 S. Susquehanna Trail | Port Trevorton, PA 17864
570-374-0284 | fax 570-374-0693
www.snydercountyproduce.com

Southern Container Corp.

6003 Ward Blvd. | Wilson, NC 27893
252-230-4958 | 252-230-1376 | 252-668-0418
www.socontainers.com

Stand’N Plant (see ad on page 18)

95 Rose Rd. | Saltsburg, PA 15681
724-639-3965 or 724-349-5167
www.standnplant.com

Statewide Bag Service (see ad on page 16)

31 Schwalm Road | Tower City PA 17980
717-647-2623
www.tallmanpotatoes.com

Stokes Seeds (see ad on page 9)

Box 548, Buffalo | NY 14240
800-263-7233 | fax – 888-834-3334
www.stokeseeds.com

Sugar Valley Produce Auction

702 South Mill St. | Loganton, PA 17747
570-725-2000

Sunnyburn Produce Auction

101 Atkins Rd | Airville, PA 17302
717-862-3010

Texpak

130 Hyde Park Rd. | Franklin Square, NY 11010
800-645-3416
www.texpak.com

Tew Manufacturing Corp. (see ad on page 8)

PO Box 87 | 470 Whitney Rd. | Penfield, NY 14526
800-380-5839 | fax 585-586-6083
www.tewmfg.com

New Wilmington Produce Auction

3238 State Route 208 | New Wilmington, PA 16142
724-946-8540

Weaverland Produce Auction

485 Quarry Rd. | New Holland, PA 17557
717-355-0834

Wes Stauffer Engine and Equipment (see ad on page 23)

23 Pleasant Valley Rd. | Ephrata, PA 17522
717-738-4215
www.wesstauffer.com

Vendors By Name

Poison Control Center 800-222-1222

Integrated Pest Management Hotline & Pesticide Update Credit Information 800-PENN-IPM

Penn State Cooperative Extension Offices

Adams	717-334-6271
Allegheny	412-263-1000
Armstrong	724-548-3447
Beaver	724-774-3003
Bedford	814-623-4800
Berks	610-378-1327
Blair	814-940-5989
Bradford	570-265-2896
Bucks	215-345-3283
Butler	724-287-4761
Cambria	814-472-7986
Cameron	814-486-3350
Carbon	570-325-2788
Centre	814-355-4897
Chester	610-696-3500
Clarion	814-223-9028
Clearfield	814-765-7878
Clinton	570-726-0022
Columbia	570-784-6660
Crawford	814-333-7460
Cumberland	717-240-6500
Dauphin	717-921-8803
Delaware	610-690-2655
Elk	814-776-5331
Erie	814-825-0900
Fayette	724-438-0111
Forest	814-755-3544
Franklin	717-263-9226
Fulton	717-485-4111
Greene	724-627-3745
Huntingdon	814-643-1660
Indiana	724-465-3880
Jefferson	814-849-7361
Juniata	717-436-7744
Lackawanna	570-963-6842
Lancaster	717-394-6851
Lawrence	724-654-8370
Lebanon	717-270-4391
Lehigh	610-391-9840
Luzerne	570-825-1701
Lycoming	570-433-3040
McKean	814-887-5613
Mercer	724-662-3141
Mifflin	717-248-9618
Monroe	570-421-6430
Montgomery	610-489-4315
Montour	570-784-6660
Northampton	610-813-6613
Northumberland	570-988-3950
Perry	717-582-5150
Philadelphia	215-471-2200
Pike	570-296-3400
Potter	814-274-8540
Schuylkill	570-622-4225
Snyder	570-556-4760
Somerset	814-445-8911

Sullivan	570-928-8941
Susquehanna	570-278-1158
Tioga	570-724-9120
Union	570-556-4760
Venango	814-437-7607
Warren	814-563-9388
Washington	724-228-6881
Wayne (extension 4110)	570-253-5970
Westmoreland	724-837-1402
Wyoming	570-836-3196
York	717-840-7408

Pennsylvania Department of Agriculture

Pesticide Regulations, Worker Protection Standards, Chemsweep Program, Plant Inspection, Food Safety Inspection - contact nearest regional office

Northwest - Meadville	814-332-6890
North Central - Montoursville	570-433-2640
Northeast- Tunkhannock	570-836-2181
Southwest - Greensburg	724-832-1073
Southwest Central - Martinsburg	814-793-1849
Southeast Central - Harrisburg	717-346-3223
Southeast - Creamery	610-489-1003
Seasonal Farm Labor	717-787-4315
Market Development	717-783-8462
PA Preferred Program	717-705-9511
Food Safety	717-787-4315
Plant Industry - Pesticides	717-787-4843
Fruit and Vegetable Inspection	717-787-4315
Farmers' Market Nutrition Program	717-772-2693
Ag Workforce Development	717-346-0426

Pennsylvania Department of Labor & Industry

General Information	717-787-5279
Workers' Compensation	800-482-2383
Right to Know	717-783-1826
Workforce Development	717-787-6521

***Not sure who to call?
Contact PVGA at 717-973-5915***



Pennsylvania Vegetable Growers Association

908 N 2nd St
Harrisburg, PA 17102

Change Service Requested

PRESORTED STANDARD
U.S. POSTAGE
PAID
HARRISBURG PA
PERMIT NO. 533



OUTSTANDING

SEED COMPANY, LLC[®]

B R E E D E R | P R O D U C E R

Foggy Morning F1

- Large, flat, blue fruit are great for stacking
- Many fruit have background speckling
- Fruit average 22 lbs
- Strong resistance to Powdery mildew

Outstanding Seed is dedicated to innovation and exceptionalism in breeding, production, and sales of stacking pumpkin, specialty pumpkin, jack-o'-lantern, and mini pumpkin hybrids.

Over sixty hybrids are available to meet many different needs. Call today to place an order or request our 2024 Catalog.

**NEW
FOR
2024**

P.O. Box 1584 | Beaver Falls, PA 15010 | 800.385.9254 | www.outstandingseed.com